



AquaTrans™ AT600 User's Manual

[no content intended for this page]

AquaTrans™ AT600

Panametrics ultrasonic flow meter for liquids

User's manual

910-312 Rev. D
September 2017

[no content intended for this page]

Contents

Product registration	vii
Services	vii
Terms and conditions	vii
Typographical conventions.....	vii
Safety issues.....	vii
Auxiliary equipment	viii
Environmental compliance.....	viii
Chapter 1. General installation instructions	1
1.1 Introduction	1
1.2 Theory of operation	2
1.3 Safety guidelines	3
1.4 Unpacking the AT600 system	3
1.5 Installing the electronics enclosure	4
1.6 Calculating the transducer spacing	5
1.7 Choosing a clamp-on fixture/transducer location	6
1.8 Mounting the clamp-on fixture and transducer system	7
Chapter 2. Clamp-on fixture and transducer installation.....	9
2.1 Installing an AT600 clamp-on fixture and transducer system	9
2.1.1 Transducer spacing = 32 to 250 mm or 50 to 320 mm, traverses = 2, fixtures = 1	9
2.1.2 Transducer spacing = 320 to 940 mm, traverses = 2, fixtures = 2	10
2.1.3 Transducer spacing = 0 to 250 mm or 0 to 320 mm, traverses = 1, fixtures = 2.....	11
2.1.4 Transducer spacing >320 mm, traverses = 1, fixtures = 2.....	12
2.2 Installing a CF-ES clamp-on fixture and transducer system.....	13
2.3 Installing a general clamping fixture and transducer system	13
2.3.1 Installing C-RS or C-PT transducers with an RG316 cable	13
2.3.2 Installing C-RS or C-PT transducers with an RG62 cable.....	13
Chapter 3. Wiring the AT600 electronics.....	14
3.1 Wiring diagram	14
3.2 Wiring the line power	16
3.3 Wiring the transducers.....	17
3.4 Wiring the system ground.....	17
3.5 Wiring the analog output for HART communication	18
3.6 Wiring the Modbus communication.....	18
3.7 Wiring the frequency/totalizer/alarm output	19
3.8 Wiring the gate input	19

Chapter 4. Initial setup and programming	20
4.1 Introduction	20
4.2 AT600 keypad operation	21
4.3 Display programming	22
4.3.1 Changing the display for one- or two-variable screens	22
4.3.2 Changing the measurement type for one- or two-variable screens	23
4.3.3 Changing the measurement type or units for the totalizer screens.....	23
4.3.4 Starting or stopping the totalizer measurement	24
4.3.5 Resetting the totalizer	24
4.4 Entering the main menu	25
4.4.1 Display format	25
4.4.2 Keypad lockout	25
4.4.3 Language	26
4.4.4 Program and program review menus.....	26
4.5 User preferences	28
4.5.1 Setting	28
4.5.2 Units setting.....	28
4.5.3 Density	29
4.5.4 Password.....	29
4.5.5 Display	30
4.6 Inputs/outputs	31
4.6.1 Programming the analog output menu.....	31
4.6.2 Programming the digital output menu	33
4.6.3 Programming the Modbus/service port.....	39
4.6.4 Programming digital communications	40
4.7 Sensor setup	42
4.7.1 Meter setup	42
4.7.2 Mounting type	43
4.7.3 Programming the pipe menu when wetted selected	43
4.7.4 Programming the pipe menu when clamp-on selected.....	44
4.7.5 Programming the transducer when clamp-on selected.....	47
4.7.6 Programming the transducer when wetted selected.....	50
4.7.7 Programming the number of traverses	51
4.7.8 Programming the fluid type.....	52
4.7.9 Programming the fluid temperature.....	53
4.7.10 Calculating the path when clamp-on selected.....	53
4.7.11 Enter the path when wetted selected	54
Chapter 5. Error codes and troubleshooting	55
5.1 Error display in the user interface	55
5.1.1 Error header.....	55
5.1.2 Flow error string.....	56

5.2 Diagnostics	58
5.2.1 Introduction	58
5.2.2 Flowcell problems	58
Chapter 6. Communication	60
6.1 MODBUS	60
6.1.1 Introduction	60
6.1.2 MODBUS register map	60
6.2 HART	72
6.2.1 Device Identification	72
6.2.2 Commands	72
6.3 Additional device status	120
6.4 Device variables	121
6.5 HART engineering units	123
Appendix A. Specifications	125
A.1 Overall operation and performance	125
A.2 Electronics	126
A.3 Clamp-on ultrasonic flow transducers	127
A.4 General	128
A.4.1 Wiring cable specifications and requirements	128
A.4.2 Cable fixing requirement and gland torque	128
A.4.3 Display languages	128
A.4.4 Product models	128
Appendix B. Data records	129
B.1 Service record	129
B.2 Data entry	129
B.3 Initial settings	130
B.4 Diagnostic parameters	131
Appendix C. Updating the firmware in the field	133
C.1 Introduction	133
C.1.1 System requirements	133
C.1.2 Preparation	133
C.2 Performing the firmware update	134
C.2.1 Check the current firmware version	134
C.2.2 Update steps	134
C.3 Clearing an S2 warning	135
C.4 Support	135

Appendix D. Menu maps 136

- D.1 The display measurement menu..... 136
- D.2 The main menu 137
- D.3 The main menu > user preferences menu 138
- D.4 The main menu > inputs/outputs menu 139
- D.5 The main menu > sensor setup menu 140
- D.6 The main menu > calibration menu141
- D.7 The main menu > advanced menu 142
- D.8 The main menu > factory menu 143

Product registration

Thank you for purchasing your AquaTrans™ AT600 from Panametrics, a Baker Hughes Company. Please register your product at <https://info.bakerhughesds.com/New-Product-Registration-LP.html> for product support such as the latest software/firmware upgrades, product information and special promotions.

Services

Panametrics provides customers with an experienced staff of customer support personnel ready to respond to technical inquiries, as well as other remote and on-site support needs. To complement our broad portfolio of industry-leading solutions, we offer several types of flexible and scalable support services including: training, product repairs, extended warranties, service agreements and more. Please visit www.bakerhughesds.com/panametrics/flow-measurement/flow-measurement-services for more details.

Terms and conditions

Sales Terms and conditions for your recent purchase of a Panametrics product, including the applicable product Warranty, can be found on our website at the following link: www.bakerhughesds.com/sales-terms-conditions

Typographical conventions

NOTE:

These paragraphs provide information that provides a deeper understanding of the situation, but is not essential to the proper completion of the instructions.

IMPORTANT:

These paragraphs provide information that emphasizes instructions that are essential to proper setup of the equipment. Failure to follow these instructions carefully may cause unreliable performance.



CAUTION!

This symbol indicates a risk of potential minor personal injury and/or severe damage to the equipment, unless these instructions are followed carefully.



WARNING!

This symbol indicates a risk of potential serious personal injury, unless these instructions are followed carefully.

Safety issues



WARNING!

It is the responsibility of the user to make sure all local, county, state and national codes, regulations, rules and laws related to safety and safe operating conditions are met for each installation.



ATTENTION EUROPEAN CUSTOMERS!



To meet CE Marking requirements for all units intended for use in the EU, all electrical cables must be installed as described in this manual.

Auxiliary equipment

Local safety standards

The user must make sure that he operates all auxiliary equipment in accordance with local codes, standards, regulations, or laws applicable to safety.

Working area

	<p>WARNING!</p> <p>Auxiliary equipment may have both manual and automatic modes of operation. As equipment can move suddenly and without warning, do not enter the work cell of this equipment during automatic operation, and do not enter the work envelope of this equipment during manual operation. If you do, serious injury can result.</p>
	<p>WARNING!</p> <p>Make sure that power to the auxiliary equipment is turned OFF and locked out before you perform maintenance procedures on this equipment.</p>

Qualification of personnel

Make sure that all personnel have manufacturer-approved training applicable to the auxiliary equipment.

Personal safety equipment

Make sure that operators and maintenance personnel have all safety equipment applicable to the auxiliary equipment. Examples include safety glasses, protective headgear, safety shoes, etc.

Unauthorized operation

Make sure that unauthorized personnel cannot gain access to the operation of the equipment.

Environmental compliance

RoHS

The AquaTrans™ AT600 fully complies with RoHS regulations (Directive 2011/65/EU).

Waste Electrical and Electronic Equipment (WEEE) directive

Panametrics is an active participant in Europe's *Waste Electrical and Electronic Equipment* (WEEE) take-back initiative (Directive 2012/19/EU).



The equipment that you bought has required the extraction and use of natural resources for its production. It may contain hazardous substances that could impact health and the environment.

In order to avoid the dissemination of those substances in our environment and to diminish the pressure on the natural resources, we encourage you to use the appropriate take-back systems. Those systems will reuse or recycle most of the materials of your end life equipment in a sound way.

The crossed-out wheeled bin symbol invites you to use those systems.

If you need more information on the collection, reuse and recycling systems, please contact your local or regional waste administration.

Please visit www.bakerhughesds.com/health-safety-and-environment-hse for take-back instructions and more information about this initiative.

Chapter 1. General installation instructions

1.1 Introduction

Thank you for purchasing the AT600 ultrasonic flow meter. The AT600 is a clamp-on ultrasonic flow meter for the measurement of liquid products. It is designed for the industrial applications, including water, wastewater, steel, campus energy, and others. The AT600 utilizes a new electronics platform and industrial design to make it extremely simple to install and use in the field.

- **So easy to use, it practically installs itself**

The AT600 consists of the new AT600 electronics, a metal enclosure, the field proven AT transducer system, and a clamp-on transducer fixture (see figure 1 below).

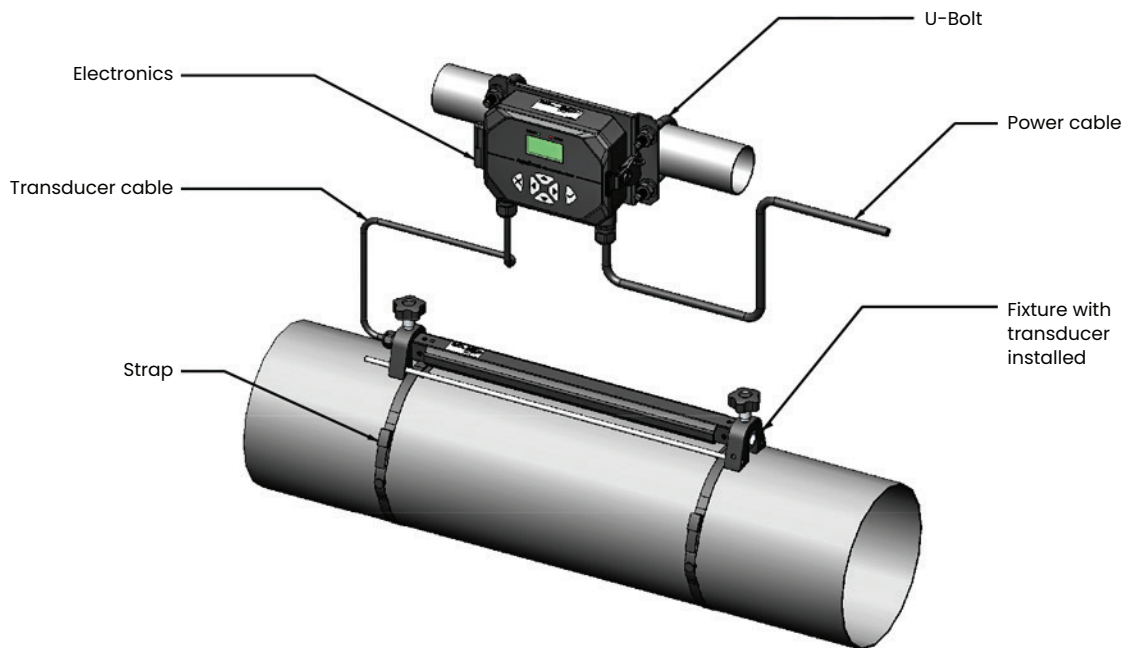


Figure 1: Typical AT600 system mounted on a pipe

1.2 Theory of operation

The AT600 flow meter uses a procedure called **transit-time flow measurement**. In this method, two transducers, which are in acoustic communication with each other, serve as both ultrasonic signal generators and receivers. That is, the second transducer can receive ultrasonic signals transmitted by the first transducer and vice versa.

In operation, each transducer functions as a transmitter, generating a certain number of acoustic pulses, and then as a receiver for an identical number of pulses (see figure 2 and figure 3 below). The time interval between transmission and reception of the ultrasonic signals is measured in both directions. When the liquid in the pipe is not flowing, the transit-time downstream equals the transit-time upstream. However, when the liquid is flowing, the transit-time downstream is less than the transit-time upstream. The difference between the downstream and upstream transit times is proportional to the velocity of the flowing liquid and its sign indicates the direction of flow.

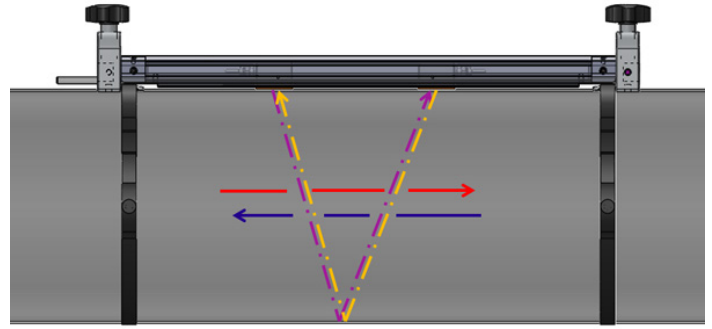


Figure 2: Flow and transducer paths (two traverses)

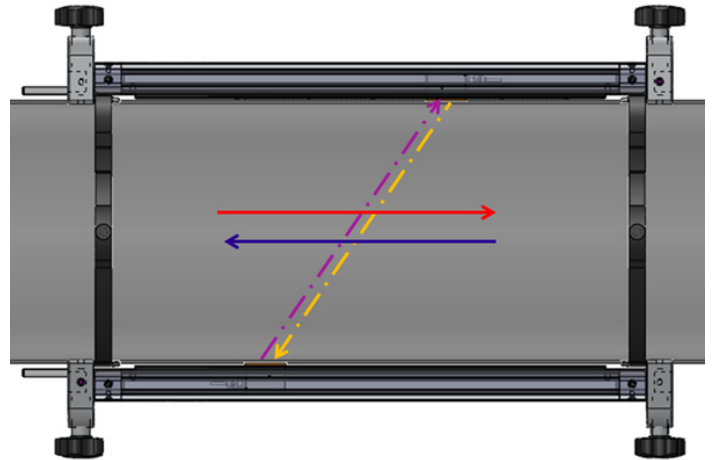




Figure 3: Flow and transducer paths (one traverse)

1.3 Safety guidelines

To ensure safe and reliable operation of the AT600, the system must be installed in accordance with the guidelines discussed in this manual. This chapter includes the following topics:

- “Unpacking the AT600 system”
- “Installing the electronics enclosure”
- “Choosing a clamp-on fixture/transducer location”
- “Mounting the clamp-on fixture and transducer system”

	WARNING! The AT 600 flow transmitter can measure the flow rate of many fluids, some of which are potentially hazardous. The importance of proper safety practices cannot be overemphasized.
---	---

	WARNING! Be sure to follow all applicable local safety codes and regulations for installing electrical equipment and working with hazardous fluids or flow conditions. Consult company safety personnel or local safety authorities to verify the safety of any procedure or practice.
---	--

	ATTENTION EUROPEAN CUSTOMERS! To meet CE marking and UL marking requirements, all cables must be installed as described in “Wiring cable specifications and requirements.”
---	--

1.4 Unpacking the AT600 system

Before removing the AT600 system from the crate, please inspect the flow meter. Before discarding any of the packing materials, account for all components and documentation listed on the packing slip. The discarding of an important item along with the packing materials is all too common. If anything is missing or damaged, contact Panametrics customer care immediately for assistance.

Please note that the AT600 system (see figure 4 below) is available in a variety of configurations to meet your needs, so the packing list will vary for each system. As an example, a typical packing list is:

1. One AT600 electronics enclosure
2. Two clamp-on fixtures
3. Two transducers (installed in one of the two clamp-on fixtures)
4. One transducer cable (installed on fixture with transducers)
5. Two clamp-on fixture mounting straps for each fixture
6. Two “U” bolts for pipe mounting of the AT600 electronics enclosure
7. One USB flash drive with user’s manual and calibration sheet
8. One inner hexagon spanner
9. Three M16 cable glands (installed on the AT600 electronics enclosure)
10. Two pieces of solid couplant
11. Quick installation guide
12. Calibration sheet
13. Cabling tools



Figure 4: Typical AT600 shipping container

1.5 Installing the electronics enclosure

The AT600 electronics is housed in a powder-coated, aluminum, NEMA type 4X/IP67 enclosure suitable for

indoor or outdoor use. See figure 5 below for the mounting dimensions and weight of the AT600 electronics enclosure.

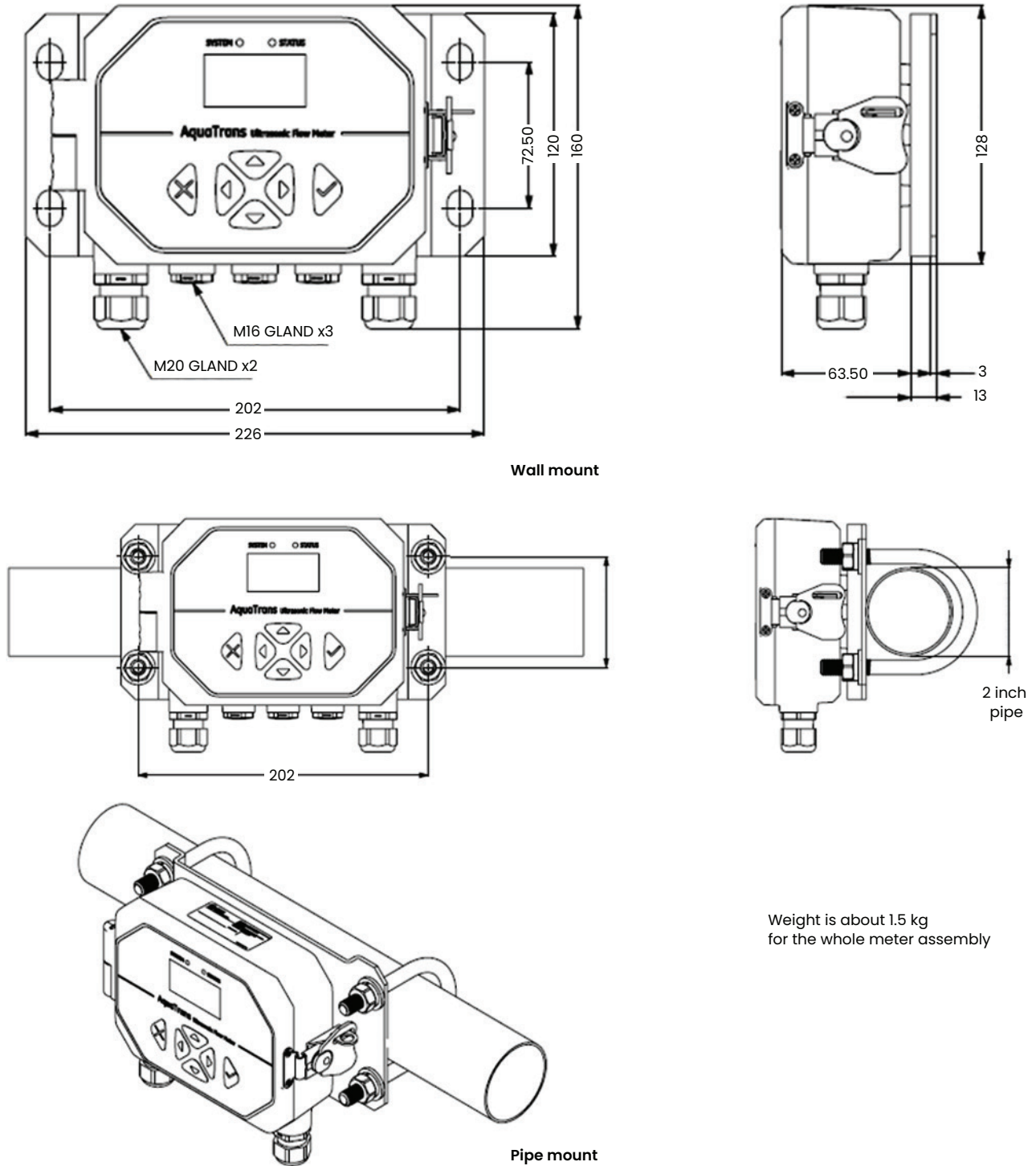


Figure 5: Mounting the AT600 electronics enclosure

The installation base of AT600 electronics enclosure can be rotated 90° to keep a horizontal view of the user interface in

any mounting orientation. See figure 6 below for drawings of the AT600 mounting base.

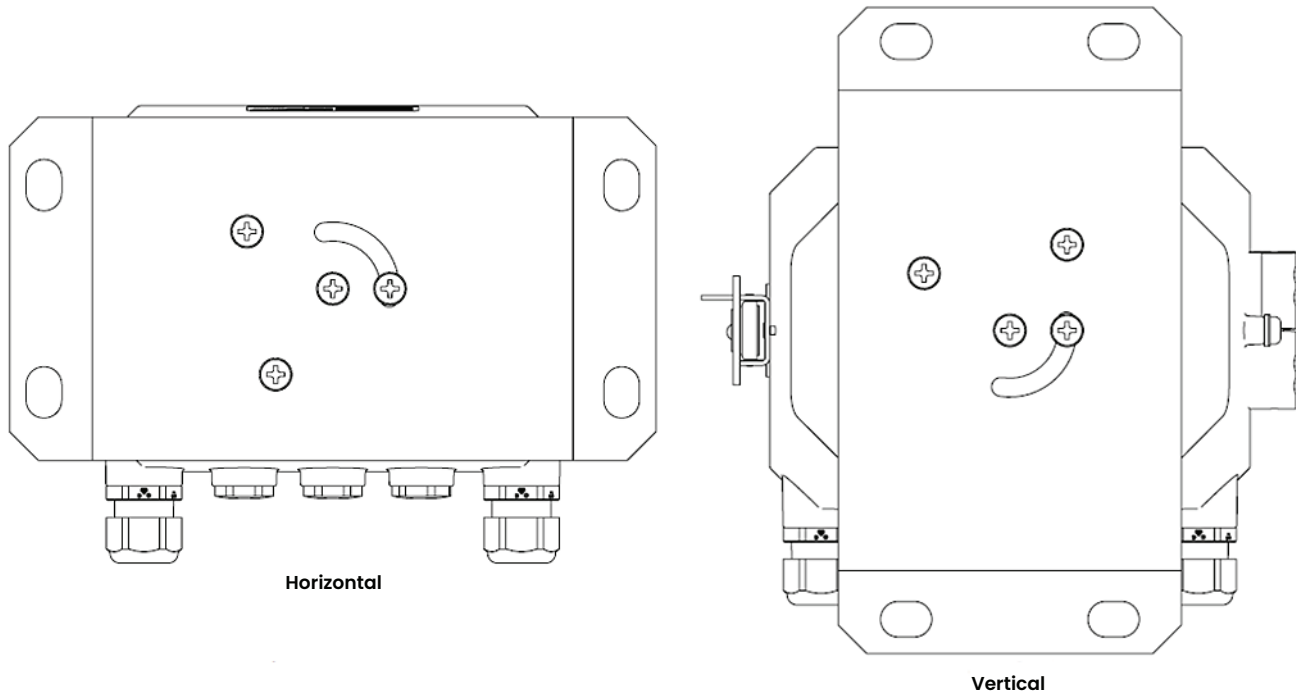


Figure 6: The AT600 mounting base

1.6 Calculating the transducer spacing

Before installing the clamp-on fixture(s) and transducers, you must program the AT600 to calculate the required transducer spacing for your planned installation. To accomplish this task, go to “*Sensor setup*” and

follow the instructions in that section. After obtaining the required transducer spacing value, return here and continue to the next section.

1.7 Choosing a clamp-on fixture/transducer location

For a given fluid and pipe, the accuracy of AT600 depends on the location and alignment of the transducers. In addition to accessibility, when choosing a transducer location, follow these guidelines:

- Position the clamp-on fixture(s) and transducer system so that there are at least 10 pipe diameters of straight, undisturbed flow upstream and 5 pipe diameters of straight, undisturbed flow downstream from the measurement point (see figure 7 below). Undisturbed flow means avoiding sources of turbulence in the fluid such as valves, flanges, expansion joints, elbows, swirl, and cavitation.
- Locate the transducers on a common axial plane along the pipe (see figure 8 below). The transducers should be mounted on the side of the pipe, rather than the top or bottom, because the top of the pipe tends to accumulate gases and the bottom tends to accumulate sediment. Either condition may cause excessive attenuation of the ultrasonic signal. There is no similar restriction with vertical pipes, as long as the flow direction is upward to prevent free falling of the fluid in a partially filled pipe.

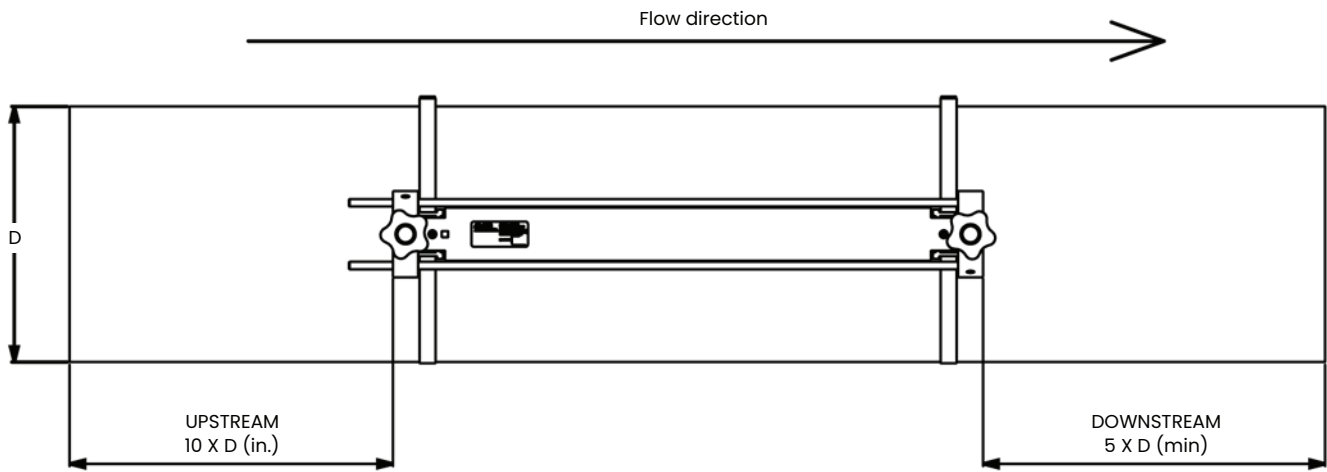


Figure 7: AT600 clamp-on fixture/transducer location

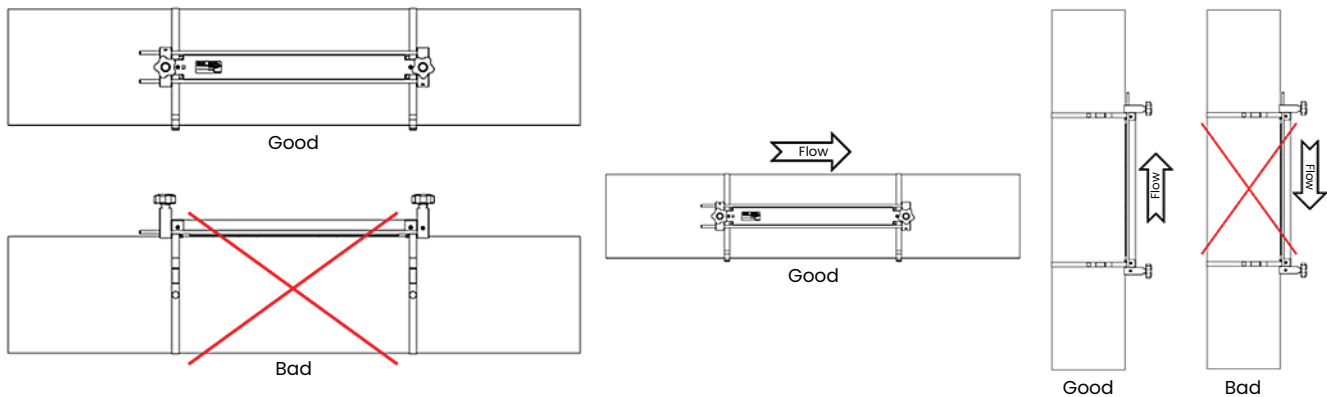


Figure 8: Good and bad transducer locations

1.8 Mounting the clamp-on fixture and transducer system

The AT600 transducer system includes one or two clamp-on fixtures, two transducers and one transducer cable. One clamp-on fixture is shipped with both transducers installed and the transducer cable connected to the transducers. This fixture is the default setup for most applications. If a second fixture has been ordered, it is shipped empty.

Transducers available for use with the AT600 flow meter are listed in table 1 below.

Table 1: Available transducers

Model	Frequency	Fixture	Pipe sizes
AT6	2, 1, 0.5 MHz	AT600	>2 in. (50 mm)
CF-LP ¹	4 MHz	CF-ES	0.5-2 in. (15-50 mm)
UTXDRI	4 MHz	SPCF	0.5-8 in. (15-200 mm)
C-RS ²	1, 0.5 MHz	GCF	>2 in. (50 mm)
C-PT ²	2, 1, 0.5 MHz	GCF	>2 in. (50 mm)

¹ Go directly to: "Installing a CF-ES clamp-on fixture and transducer system."

² Go directly to: "Installing a General clamping fixture and transducer system."

The AT600 clamp-on fixture and AT6 transducer system can be installed on pipe sizes >2 in. (50 mm). For optimum performance in any specific application, either a two-traverse or one-traverse installation can be chosen. Because the maximum pipe size for a single clamp-on fixture is 250 mm for 2 MHz transducers or 320 mm for 1 MHz and 0.5 MHz transducers, the detailed installation requirements differ based on the calculated transducer spacing and the chosen number of traverses. Refer to table 2 below to find the parameters for your specific configuration.

IMPORTANT:

See "Sensor setup" to calculate the required transducer spacing. A two traverse installation is recommended for most applications.

IMPORTANT:

If there is any type of coating or protective layer on the outer pipe surface, it must be removed at the locations where the transducers and couplant contact the pipe surface.

From the information on the previous page and the documentation included with your AT600 flow meter system, you should already know the following details about your installation:

- Pipe size
- Transducer model
- Transducer frequency
- Number of traverses
- Calculated transducer spacing
- Number of clamp-on fixtures

Based on the known information, proceed directly to one of the following sections in the next chapter for instructions on installing your AT600 clamp-on fixture(s) and transducers on the pipe:

NOTE:

See the flowchart in figure 9 to assist in choosing the appropriate instructions for your specific configuration.

- "Transducer spacing = 32 to 250 mm or 50 to 320 mm, traverses = 2, fixtures = 1"
- "Transducer spacing = 320 to 940 mm, traverses = 2, fixtures = 2"
- "Transducer spacing = 0 to 250 mm or 0 to 320 mm, traverses = 1, fixtures = 2"
- "Transducer spacing >320 mm, traverses = 1, fixtures = 2"

Table 2: AT600 clamp-on fixture installation

Pipe size range		Transducer frequency (MHz)	Number of traverses	Transducer spacing (mm)	Number of fixtures
mm	inches				
50 to 100	2 to 4	2	4	32 to 250	1
100 to 150	4 to 6	2	2	32 to 250	1
50 to 150	2 to 6	2	1	0 to 250	2
100 to 300	4 to 12	1	2	50 to 320	1
300 to 600	12 to 24	1	2	320 to 940	2
600 to 1500	24 to 60	1	1	>320	2
200 to 300	8 to 12	0.5	2	50 to 320	1
300 to 900	12 to 36	0.5	2	320 to 940	2
>900	>36	0.5	1	>320	2

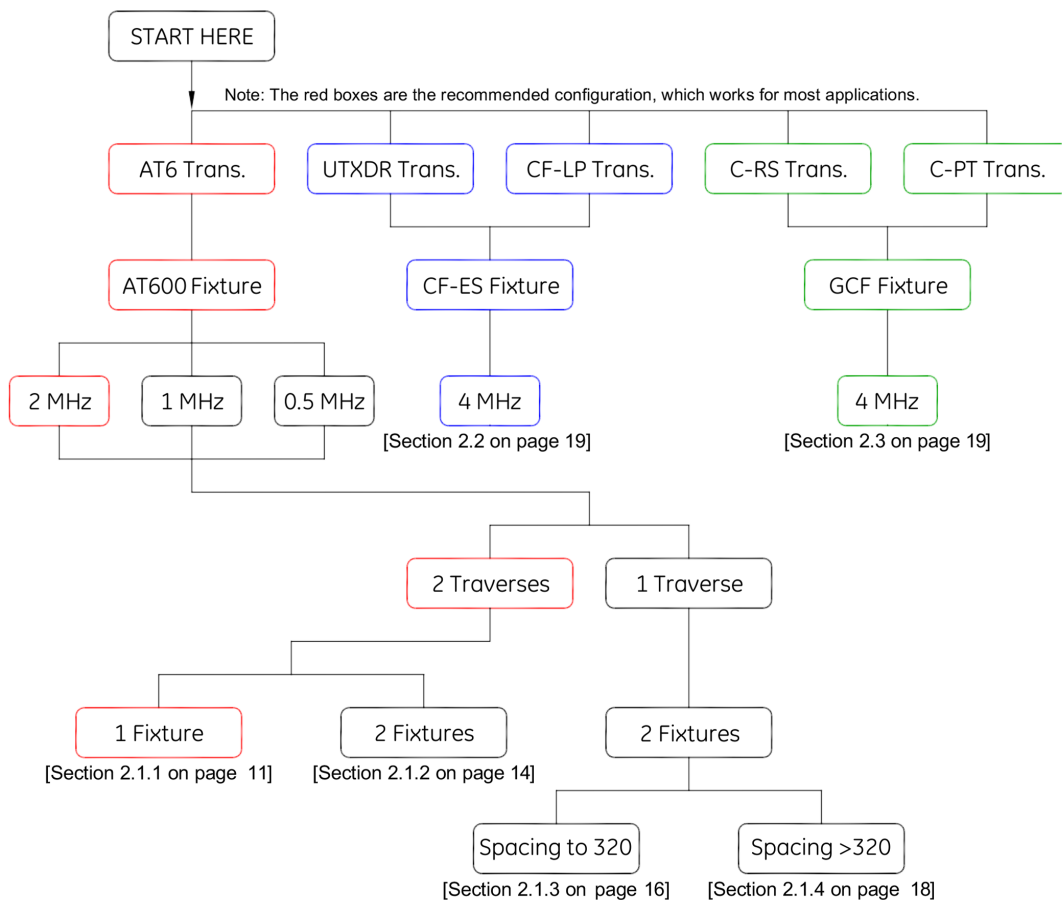


Figure 9: Flowchart to transducer installation instructions

Chapter 2. Clamp-on fixture and transducer installation

2.1 Installing an AT600 clamp-on fixture and transducer system

The instructions in this section are for installations using the AT600 clamp-on fixture only. For installations using other clamp-on fixtures, see “Installing a CF-ES clamp-on fixture and transducer system” or “Installing a general clamping fixture and transducer system.”

2.1.1 Transducer spacing = 32 to 250 mm or 50 to 320 mm, traverses = 2, fixtures = 1

NOTE:

A two traverse installation with one clamp-on fixture is the standard AT600 configuration.

When the required transducer spacing is 32 to 250 mm for a 2 MHz transducer or 50 to 320 mm for a 1 MHz or MHz transducer, one clamp-on fixture is needed for a dual traverse installation. Proceed as follows:

1. Install the AT600 clamp-on fixture with transducers on the pipe using two mounting straps.
 - a. Choose a location with enough straight pipe run (refer to figure 7).
 - b. Install the two mounting straps on the pipe about 12 in. (30 cm) apart (see figure 10 below).

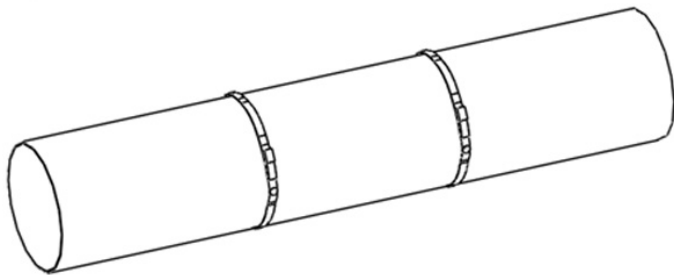


Figure 10: Mounting straps installed on pipe

- c. Hold the fixture against the pipe and move the mounting straps onto the fixture. Then, tighten the screws on the straps, and verify that the straps remain in place on the fixture (see figure 11 below).

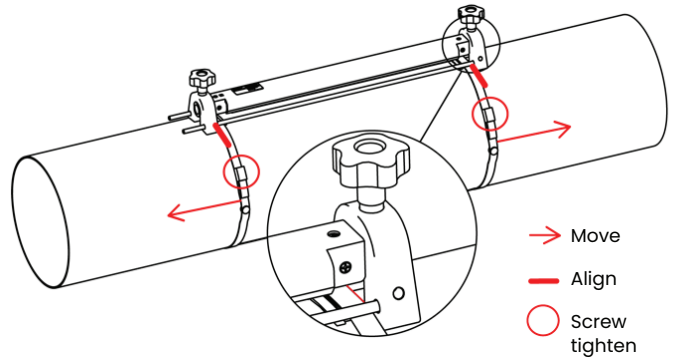


Figure 11: 2 Traverse installation with 1 clamp-on fixture

IMPORTANT:

If there is any type of coating or protective layer on the outer pipe surface, it must be removed at the locations where the transducers and the couplant contact the pipe surface.

2. Connect the power and transducer cables to the AT600, as shown in figure 23.
3. If you haven't already done so, power the meter on and program your site data to determine the required transducer spacing (see “Sensor setup”).
4. Set the two transducers at the spacing calculated by the meter and tighten them in place, as follows:
 - a. Loosen both transducers and rotate the fixture so that the transducers are in view (see figure 12 below).

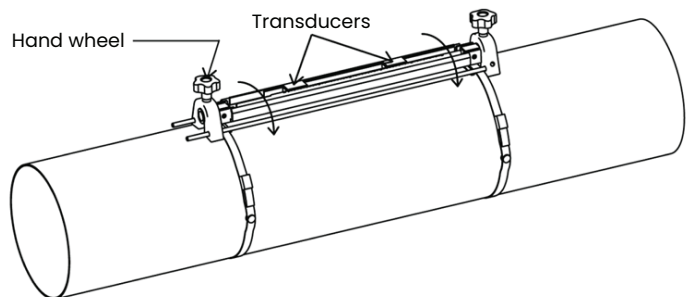


Figure 12: Transducers rotated into view

- b. Set the transducers to the spacing calculated by the meter. If you are using solid couplant, apply it to both transducer faces. Then, rotate the transducers back onto the rail (see figure 13 below).

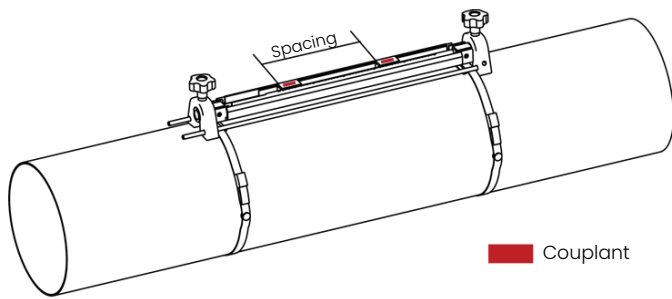


Figure 13: Set transducer spacing and apply couplant

5. See figure 14 below for an example of a completed installation. In this drawing, **LSL** is the *lower specified limit* and **USL** is the *upper specified limit* for the installation.

NOTE:

For a one-fixture installation, **LSL** is **0** on the scale and **USL** is **250 mm** for a 2 MHz transducer or **320 mm** for a 1 MHz or 0.5 MHz transducer. The transducer spacing is measured from **LSL** to a point \leq **USL**.

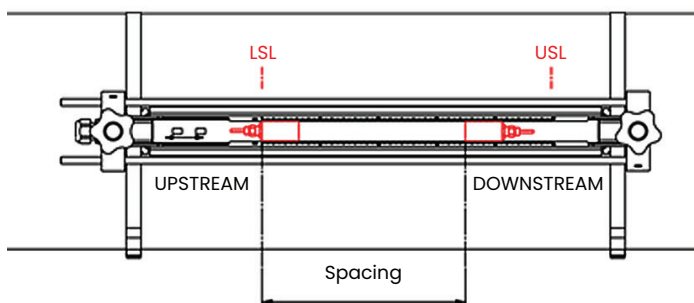


Figure 14: Installation for two traverses with one fixture

6. Your clamp-on fixture and transducer installation is now complete. To wire your AT600 flow meter, proceed to "Wiring the AT600 electronics."

2.1.2 Transducer spacing = 320 to 940 mm, traverses = 2, fixtures = 2

For a two traverse installation with a calculated transducer spacing of 320 to 940 mm for a 1 MHz or 0.5 MHz transducer, two fixtures are installed on the same side of the pipe. To do so, complete the following steps:

1. Install the four mounting straps on the pipe with a spacing of 12 in. (30 cm) between each pair of straps.
2. Hold one of the clamp-on fixtures, with two transducers and one cable, against the pipe between the upstream pair of straps and move the two mounting straps onto the fixture (see figure 15 below). Then, tighten the screws on the mounting straps, and verify that the straps remain in place on the fixture.

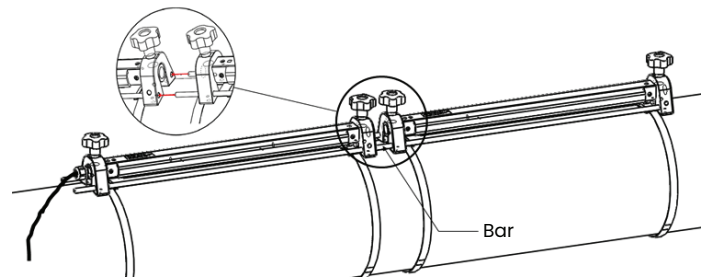


Figure 15: Two traverse installation with two clamp-on fixtures

3. Repeat step 2 to install the second clamping fixture, with no transducers or cable, on the pipe between the downstream pair of straps. Use the bar on the second fixture to connect the two fixtures. Then, move the straps onto the second fixture and tighten the screws.

IMPORTANT:

Be sure the bar on the left side of the second fixture is in close contact with the bar on the first fixture.

4. Set the spacing between the two transducers in the upstream clamping fixture to the value calculated by the meter and tighten them back onto the pipe, as follows:
 - a. Rotate the fixture so that the transducers are in view (see figure 12).
 - b. Remove the downstream transducer from the first fixture (see figure 16 below), disconnect the transducer cable, and route the cable into the second fixture. Then, install the downstream transducer into the second fixture and reconnect the transducer cable. If you are using solid couplant, apply it to both transducer faces. Then, rotate the transducers back onto the rail.

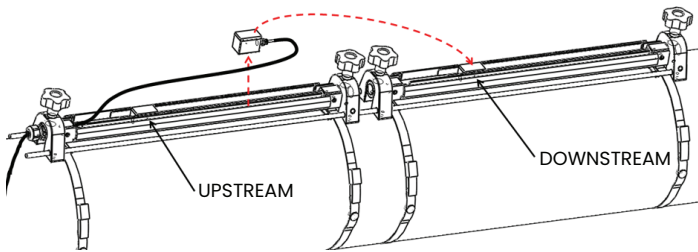


Figure 16: Moving the downstream transducer

IMPORTANT:

Tight contact must be made between the bars on the two fixtures to ensure an accurate spacing.

- See figure 17 and figure 18 below for examples of a completed installation in the following situations:

NOTE:

In this drawing, **LSL** is the lower specified limit and **USL** is the upper specified limit for each fixture.

- For a calculated transducer spacing of 320 to 620 mm for a 1 MHz or 0.5 MHz transducer, locate the upstream transducer at the **USL1** position on the first fixture. Then, locate the downstream transducer at the calculated transducer spacing position (\leq **USL2**) on the second fixture.

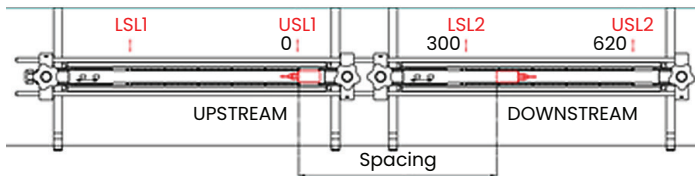


Figure 17: Transducer spacing of 320 to 620 mm with two fixtures

- For a calculated transducer spacing of 620 to 940 mm for a 1 MHz or 0.5 MHz transducer, locate the upstream transducer at the **LSL1** position on the first fixture. Then, locate the downstream transducer at the calculated transducer spacing position (between **LSL2** and **USL2**) on the second fixture.

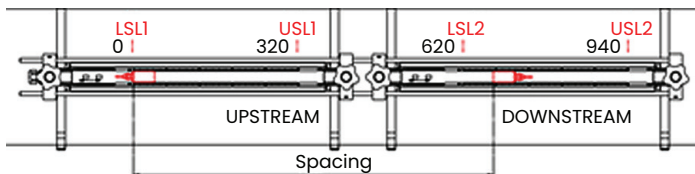


Figure 18: Transducer spacing of 620 to 940 mm with two fixtures

- Your clamp-on fixture and transducer installation is now complete. To wire your AT600 flow meter, proceed to "Wiring the AT600 electronics."

2.1.3 Transducer spacing = 0 to 250 mm or 0 to 320 mm, traverses = 1, fixtures = 2

For a one traverse installation with a calculated transducer spacing of 0 to 250 mm for a 2 MHz transducer or 0 to 320 mm for a 1 MHz or 0.5 MHz transducer, two clamp-on fixtures are installed on opposite sides of the pipe. To install this configuration, complete the following steps:

- Mark a straight line parallel to the pipe centerline on the top of the pipe (i.e., the 12 o'clock position).
- Use a band tape to measure the circumference of the pipe. Then, mark two additional lines on the pipe parallel to the first line. Locate these lines 1/4 of the way around the pipe in each direction from the original line (i.e., at the 3 o'clock and 9 o'clock positions).
- Install two mounting straps on the pipe about 12 in. (30 cm) apart (see figure 19 below).
- Hold one clamp-on fixture, with two transducers and one cable, on the pipe along one of the lines marked in step 2. Then, move the two straps onto the ends of this fixture.
- Hold the remaining (empty) clamp-on fixture on the opposite side of the pipe from the first fixture. Then, move the two straps onto the ends of this clamp-on fixture.
- Align the two fixtures to be equal distances from the band tape. Tighten both straps securely.

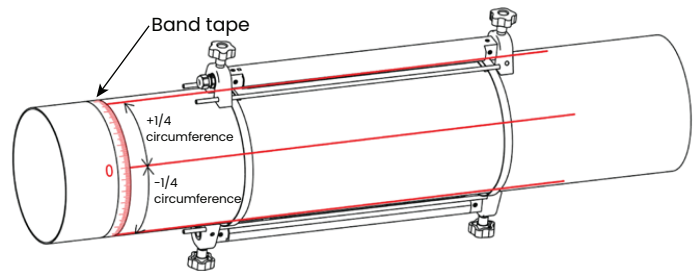


Figure 19: One traverse installation with two fixtures

- Set the spacing between the two transducers to the value calculated by the meter as follows:
 - Loosen the fixture rails and rotate the rails so the transducers are in view.
 - Remove the upstream transducer from the first fixture (see figure 20 below). Disconnect the transducer cable and route the cable into the second fixture.

NOTE:

The cable for the upstream transducer needs to be pulled out through one side of the rail on the first fixture and inserted through the side of the rail on the second fixture.

- Install the upstream transducer into the second fixture, and reconnect the transducer cable.
- Locate the upstream transducer at the zero position of the second fixture, and then move the downstream transducer to the required position on the first fixture. If you are using solid couplant, apply it to both transducer faces. Then, rotate the transducers back onto the rail.

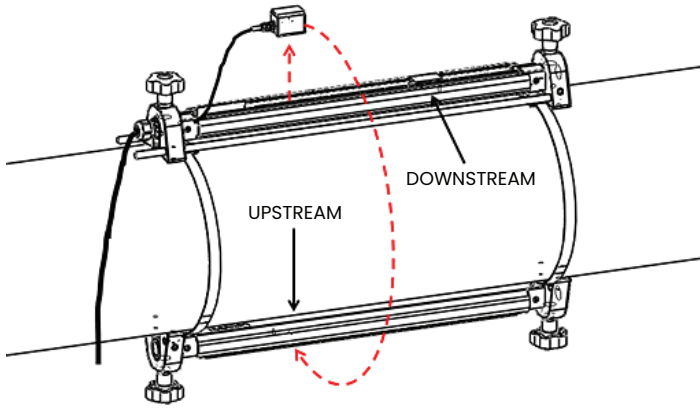


Figure 20: Relocate the upstream transducer

8. Your clamp-on fixture and transducer installation is now complete. To wire your AT600 flow meter, proceed to *"Wiring the AT600 electronics."*

2.1.4 Transducer spacing >320 mm, traverses = 1, fixtures = 2

For a one traverse installation with a calculated transducer spacing of >320 mm for a 1 MHz or 0.5 MHz transducer, two clamp-on fixtures are installed on opposite sides of the pipe. To install this configuration, refer to figure 21 below and complete the following steps:

1. Mark a straight line parallel to the pipe centerline on the top of the pipe (i.e., the 12 o'clock position).
2. Use a band tape to measure the circumference of the pipe. Then, mark two additional lines on the pipe parallel to the first line. Locate these lines 1/4 of the way around the pipe in each direction from the original line (i.e., at the 3 o'clock and 9 o'clock positions).
3. Install the four mounting straps on the pipe with a spacing of about 12 in. (30 cm) between each pair of straps. Then, mark a fixture position on each of the straight lines, using the band tape as a reference point.
4. Hold one clamp-on fixture, with two transducers and one cable, on the pipe between the pair of downstream straps and along one of the lines marked in step 2. Then, move the two downstream straps onto the ends of this clamp-on fixture. Tighten the strap screws and verify that the straps remain on the ends of the fixture.
5. Hold the remaining (empty) clamp-on fixture along the line on the opposite side of the pipe from the first fixture and between the upstream pair of straps. Then, move the two upstream straps onto the ends of this clamp-on fixture. Tighten the strap screws and verify that the straps remain on the ends of the fixture.

6. Set the spacing between the two transducers to the value calculated by the meter as follows:
 - a. Loosen the fixture rails and rotate the rails so the transducers are in view.
 - b. Remove the upstream transducer from the first fixture (see figure 21 below). Disconnect the transducer cable and route the cable into the second fixture.
 - c. Install the upstream transducer in the second fixture, and reconnect the transducer cable.
 - d. Locate the upstream transducer at the zero position of the second fixture, and then move the downstream transducer to the required position on the first fixture. If you are using solid couplant, apply it to both transducer faces. Then, rotate the transducers back onto the rail.

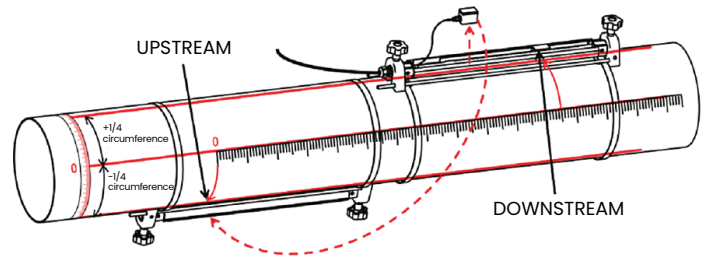


Figure 21: 1 Traverse installation for transducer spacing >320 mm

7. Your clamp-on fixture and transducer installation is now complete. To wire your AT600 flow meter, proceed to *"Wiring the AT600 electronics."*

2.2 Installing a CF-ES clamp-on fixture and transducer system

To use the AT600 flow meter on 0.5 to 2 in. (15 to 50 mm) pipes, the **CF-ES** clamp-on fixture must be used.

UTXDR or **CF-LP** transducers are available for installation in this fixture. Note the following specifications:

- **UTXDR** transducer: Use cable adapter p/n 704-1678-LF with the AT6 transducer cable, -40 to +120°C (-40 to +248°F) temperatures, 4 MHz frequency
- **CF-LP** transducer: Use cable adapter p/n 210-410-LF with the AT6 transducer cable, up to 230°C (446°F) temperatures, 4 MHz frequency.

Detailed installation instructions for this fixture and transducer are available in Panametrics document #916-082.

2.3 Installing a general clamping fixture and transducer system

Both the **C-RS** and **C-PT** transducers are mounted on the pipe with the Panametrics general clamping fixture (**GCF**). For detailed installation instructions refer to following:

- C-RS transducer installation Guide (Panametrics document #916-077)
- C-PT transducer installation Guide (Panametrics document #916-074)

2.3.1 Installing C-RS or C-PT transducers with an RG316 cable

The standard AT6 transducer cable is an RG316 cable with an **SMA** connector on the transducer end. To connect the **BNC** connector on the C-RS or C-PT transducer to the SMA connector on the AT6 transducer cable, a **BNC to SMA adapter** is needed. See figure 22 below and install the cable adapter on the transducer end of your AT6 cable.

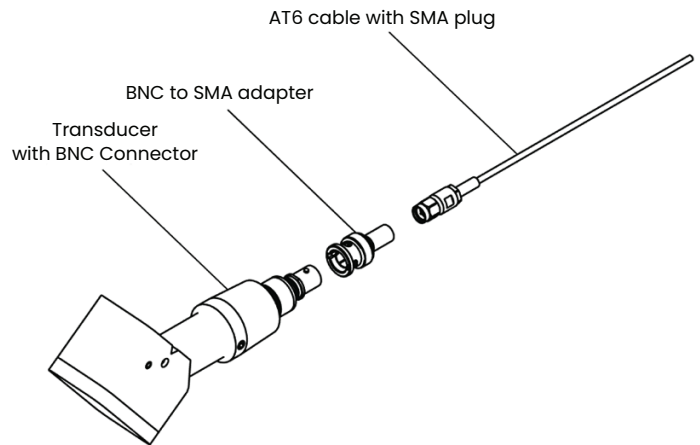


Figure 22: BNC to SMA cable adapter installation

2.3.2 Installing C-RS or C-PT transducers with an RG62 cable

The AT600 flow meter can be connected directly to a C-RS or C-PT transducer with an optional RG62 cable, which has a BNC connector at transducer end. Thus, the **BNC to SMA adapter** is not needed.

This RG62 cable has a submersible cable option for the C-RS transducer. Also, there is a junction box option for the C-RS and C-PT transducers, which provides extra physical protection for the BNC connection on the transducer.

Chapter 3. Wiring the AT600 electronics

3.1 Wiring diagram



ATTENTION EUROPEAN CUSTOMERS!

To meet CE Mark requirements, all cables must be installed as described in "Wiring cable specifications and requirements."

This section includes instructions for making all the necessary electrical connections to the AT600 flow meter. Refer to figure 23 below for the complete wiring diagram of the meter.

IMPORTANT:

Except for the transducer connector, all electrical connectors are stored in their terminal blocks during shipment and may be removed from the enclosure for more convenient wiring. Feed the cables through the cable gland holes on the bottom of the enclosure, attach the wires to the appropriate connectors and plug the connectors back into their terminal blocks.

After the AT600 is completely wired, proceed to "Initial setup and programming" to configure the meter for operation.

NOTE:

The HART and Modbus communication options must be selected when ordering the AT600.

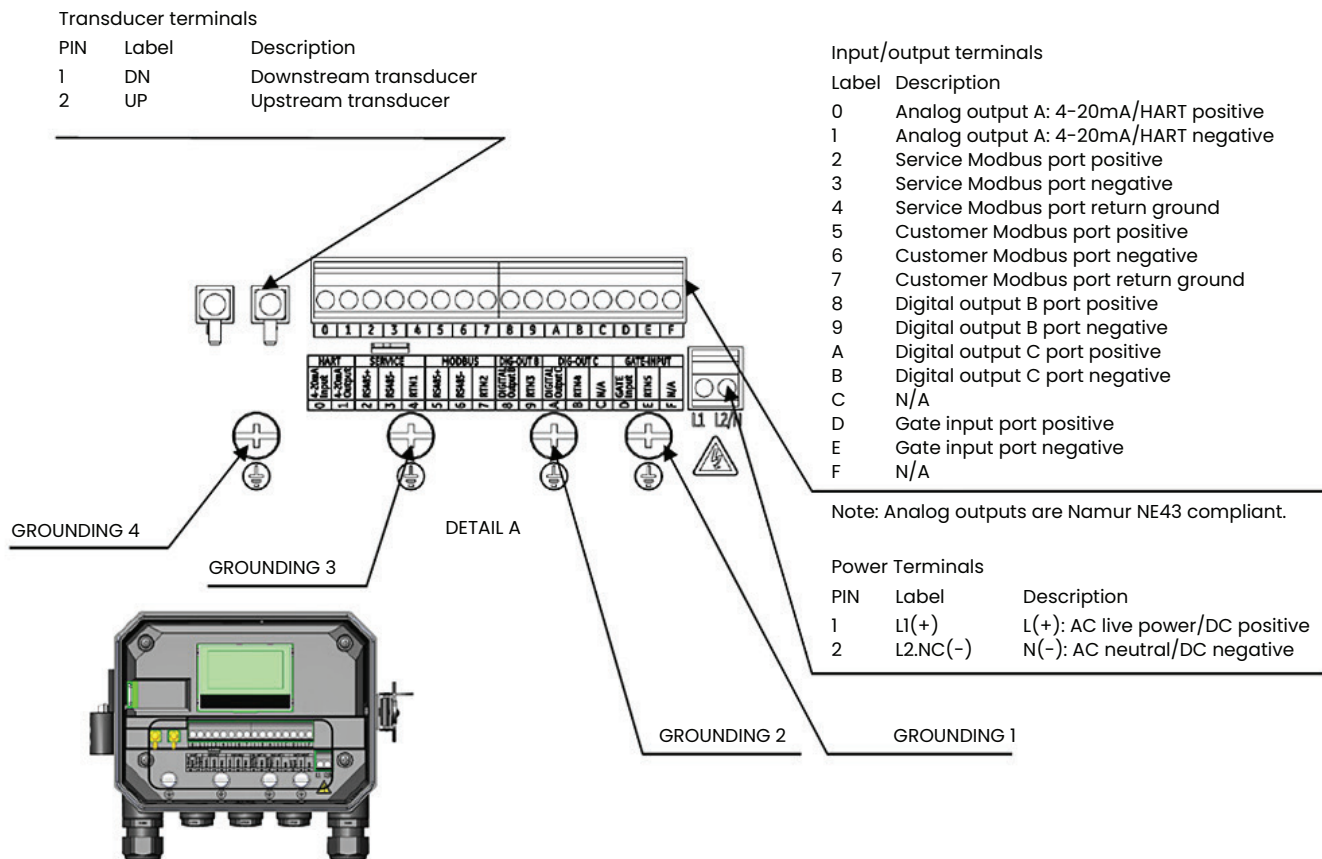
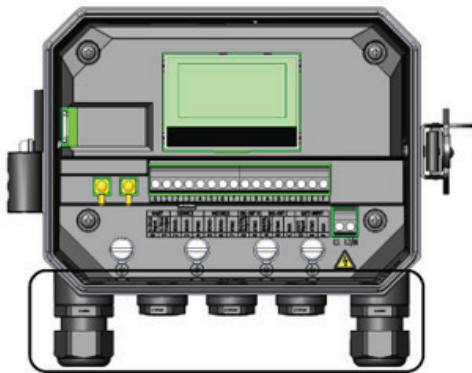
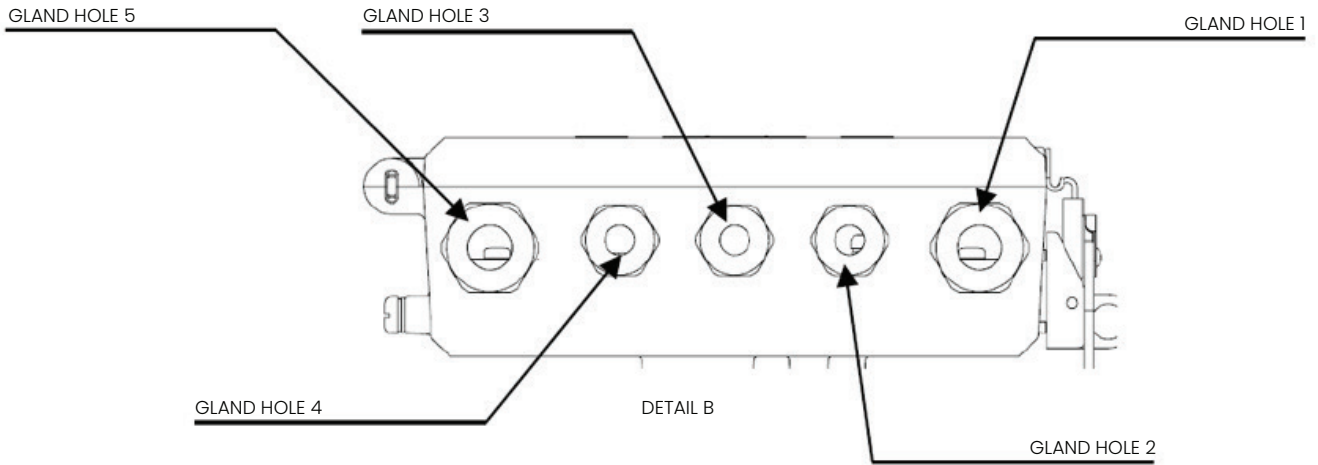


Figure 23: Wiring diagram

For proper wiring, the power lines, transducer cable and I/O lines must be routed through the appropriate cable glands (see figure 24 below). Also, refer to "Wiring cable specifications and requirements" for the required cable specifications.

IMPORTANT:

Any unused cable glands must be plugged with the *cable gland inserts* provided with meter.



CABLE GLAND HOLES

Hole num.	Feed-through cables
1	Power lines
2	Digital output B cable lines Digital output C cable lines Gate input cable lines
3	Service Modbus cable lines Customer Modbus cable lines
4	Analog output A cable lines
5	Transducer cable lines

Figure 24: Recommended cable gland usage

3.2 Wiring the line power



ATTENTION EUROPEAN CUSTOMERS!

To meet CE marking requirements, all cables must be installed as described in "Wiring cable specifications and requirements."

The AT600 may be ordered for operation with power inputs of either **85-264 VAC** or **12-28 VDC**. The label on the shroud inside the electronics enclosure lists the required line voltage for your meter.



WARNING!

Be sure to connect the AT600 only to the specified line voltage.

Examples of AT600 labels indicating the required line voltage are shown in figure 25 below.



ATTENTION EUROPEAN CUSTOMERS!

For compliance with the European Union's low voltage directive, this unit requires an external power disconnect device such as a switch or circuit breaker. The disconnect device must be marked as such, clearly visible, directly accessible, and located within 1.8 m (6 ft) of the unit.

Refer to figure 23 to locate the terminal block and connect the line power as follows:



WARNING!

Improper connection of the line power leads or connecting the meter to the incorrect line voltage will damage the unit. It will also result in hazardous voltages at the flowcell and associated piping and within the electronics console.

1. Strip 1/4" of insulation from the end of the line and neutral AC leads (or the positive and negative DC leads), and 1/2" of insulation from the end of the ground lead.
2. Connect the ground lead to the internal ground connection (GROUNDING 1) located on the bottom panel of the electronics enclosure (see figure 23).

IMPORTANT:

The incoming ground lead must be connected to the internal ground connection.

3. Connect the neutral AC lead (or the negative - DC lead) to L2/N(-) and the AC line lead (or the positive DC lead) to L1(+), as shown in figure 23.

IMPORTANT:

Do not remove the existing PC board ground wire or the cover ground wire.

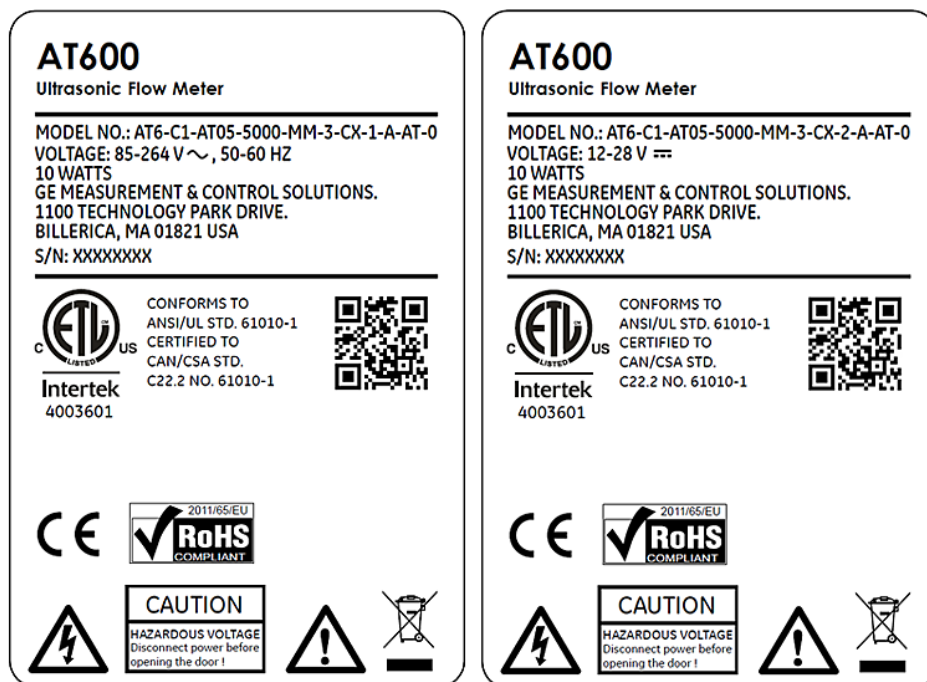


Figure 25: Typical meter S/N label (AC and DC versions)

3.3 Wiring the transducers



ATTENTION EUROPEAN CUSTOMERS!

To meet CE Mark requirements, all cables must be installed as described in “*Wiring cable specifications and requirements.*”

Wiring a typical AT600 system requires interconnection of the following components:

- Upstream and downstream transducers installed in the clamping fixtures)
- The electronics console

To wire the transducers, complete the following steps:



WARNING!

Before connecting the transducers, take them to a safe area and discharge any static build-up by shorting the center conductor of the transducer cables to the metal shield on the cable connector.

1. Locate the two transducer cables and connect them to the transducers.
2. Connect the cable connector with *yellow* DN jacket on the cable to the DN terminal, and connect cable connector with *white* UP jacket on the cable to the UP terminal, as shown in figure 23.
3. Secure the cable gland.

IMPORTANT:

Be sure to insert all cable connectors straight into the PCB receptacles to avoid damaging the connector and/or the receptacle.

3.4 Wiring the system ground



WARNING!

The AT600 must always be connected to a proper earth ground, using the *system grounding screw* shown in figure 26 below.

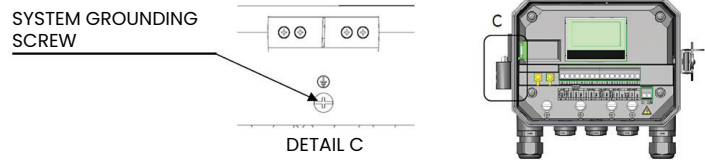


Figure 26: System grounding screw

3.5 Wiring the analog output for HART communication

The standard configuration of the model AT600 flow meter includes one isolated 0/4-20mA analog output. Connections to this output may be made with standard twisted-pair wiring. The current loop impedance for this circuit must not exceed 600 ohms.

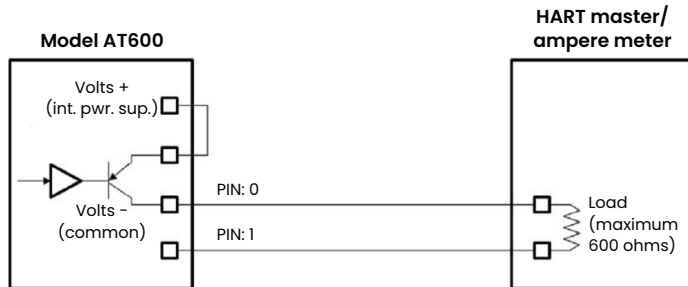


Figure 27: Analog output/HART communication wiring



WARNING!

Always be sure to disconnect the main power supply from the AT600 before proceeding with these instructions.

To wire the analog output, refer to figure 27 and complete the following steps:

1. Verify that the main power has been disconnected from the unit, and then open the enclosure.
2. Install the required cable gland in the chosen gland hole on the bottom of the enclosure.
3. Refer to figure 23 for the location of terminal block I/O, and wire the terminal block as shown above.
4. Secure the cable clamp.

Note the following:

- The standard analog output port provides only a 0/4-20mA analog output. If the HART communication option is desired, it must be specified at the time of purchase.
- The AT600 analog output is an active mode type, with power provided internally by the meter. **Do not** connect an external 24V power supply to this circuit.
- Prior to use, the analog output must be set up and calibrated (see "Inputs/outputs").
- When in meter is in configuration mode, the analog output is locked at 3.6 mA. After exiting from configuration mode, the meter will resume normal operation.

3.6 Wiring the Modbus communication

The optional AT600 Modbus port is a two-wire, half-duplex RS485 interface. If this option was specified at the time of purchase, proceed with the wiring instructions below.



WARNING!

Always be sure to disconnect the main power supply from the AT600 before proceeding with these instructions.

To wire the Modbus RS485 serial port, refer to figure 23 above and complete the following steps:

1. Verify that the main power has been disconnected from the unit, and then open the enclosure.
2. Install the required cable clamp in the chosen gland hole on the side of the electronics enclosure.
3. Route one end of the cable through the gland hole and wire it to terminal block.
4. Secure the cable clamp.

3.7 Wiring the frequency/totalizer/ alarm output

The AT600 can accommodate up to two digital outputs. Each of these outputs can be configured as either a totalizer, frequency or alarm output (see “Programming digital communications” for instructions).

Each totalizer/frequency/alarm output requires a twisted pair cable. Wire the terminal block as shown in figure 23 and figure 28 below.

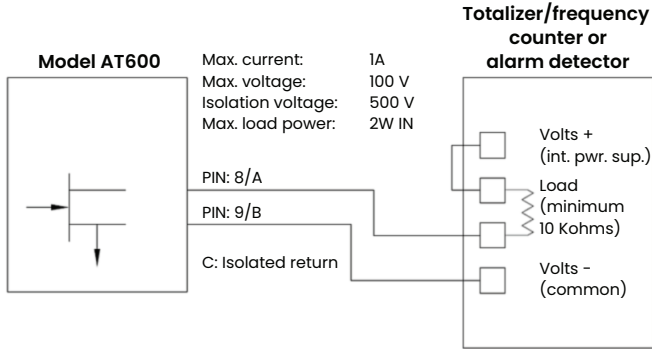


Figure 28: Totalizer/frequency/alarm output wiring

3.8 Wiring the gate input

The AT600 provides a gate contact input port. This port is designed to start/stop the totalizer. During normal measurement mode, the operator can start or stop the totalizer functionality by toggling the gate switch.



WARNING!

Always be sure to disconnect the main power supply from the AT600 before proceeding with these instructions.

To wire the Gate input, refer to figure 23 and figure 29 below and complete the following steps:

1. Verify that the main power has been disconnected from the unit, and then open the enclosure.
2. Install the required cable clamp in the chosen gland hole on the side of the electronics enclosure.
3. Route one end of the cable through the gland hole and wire it to terminal block.
4. Secure the cable clamp.

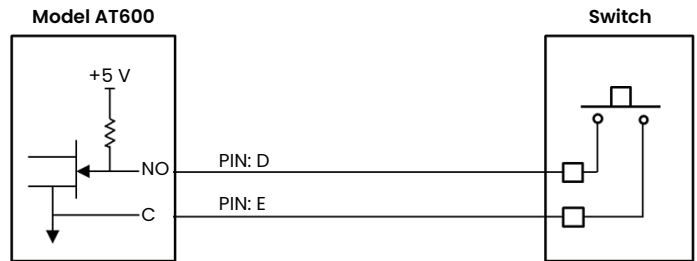


Figure 29: Gate input wiring

Chapter 4. Initial setup and programming

4.1 Introduction

This chapter provides instructions for programming the AT600 flow meter to place it into service. Before the AT600 can begin taking measurements, at least the following menus must be programmed:

- "User preferences"
- "Inputs/outputs"
- "Sensor setup"

Refer to the main menu map in figure 30 below, and proceed to the appropriate section for instructions.

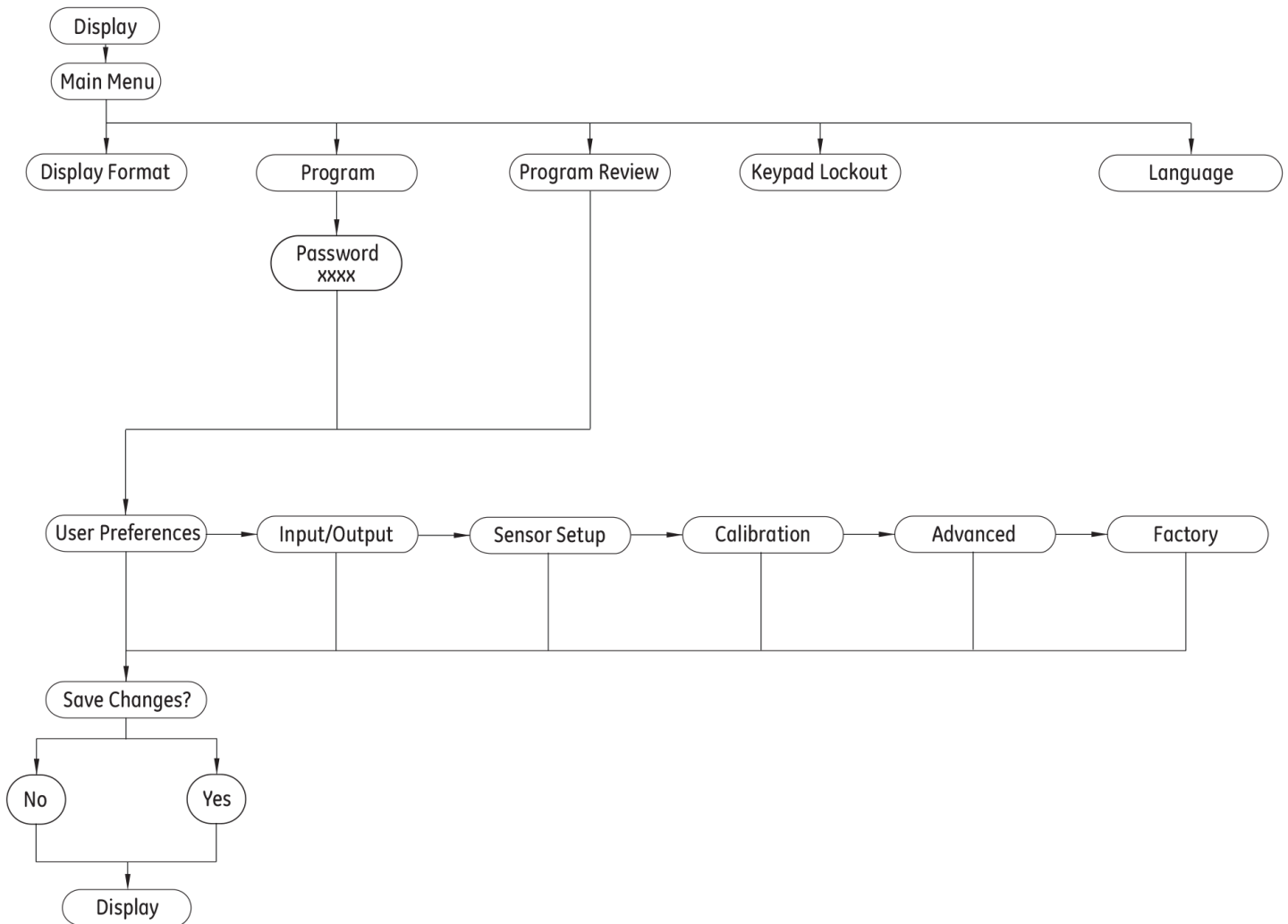


Figure 30: Main menu map

4.2 AT600 keypad operation

There are six keys and two LEDs on the AT600 keypad. The green light is a system health indicator and is on when the meter is operational and not in error. The red light is a system status indicator and is on when the meter is in error. Both lights being off indicates that the system is in configuration mode or no power has been applied to the meter.



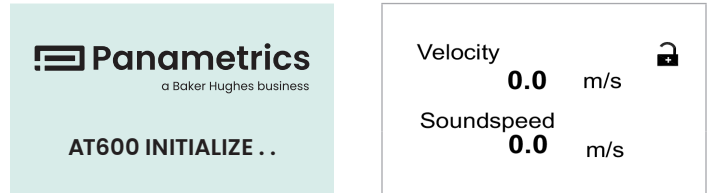
Figure 31: The AT600 keypad

The six keys on the keypad enable users to program the AT600:

- [✓] – confirms the choice of a specific option and all data entry within that option
- [✕] – enables users to exit from a specific option without saving unconfirmed data

- [△] and [▽] – enable users to highlight a specific window in the display option or to scroll through a list of options. They are also used to change individual characters in a text string.
- [◀] and [▶] – enable users to scroll to a specific menu option, or to highlight a specific character in a text string.

When powered on, the AT600 initialization screen is shown, followed by a measurement display (see below).



As a guide in following the programming instructions in this chapter, the complete AT600 menu maps can be found in “Menu maps” and the relevant portions are reproduced throughout this chapter.

IMPORTANT:

If no key has been pressed for 5 minutes, the AT600 exits the keypad program and returns to displaying measurements. Any unconfirmed configuration changes are discarded.

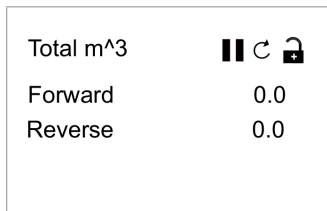
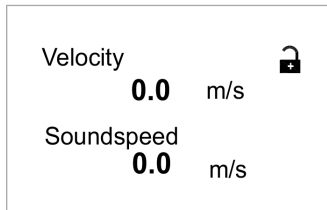
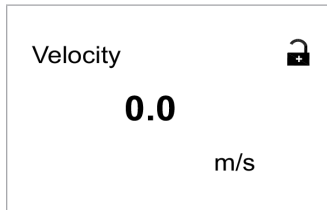
4.3 Display programming

The AT600 keypad has six keys (see "AT600 keypad operation") and the following two LEDs:

- **Green:** The green LED is a system health indicator and it is on when the meter is operating without error.
- **Red:** The red LED is a system status indicator and it is on whenever the meter is in error.

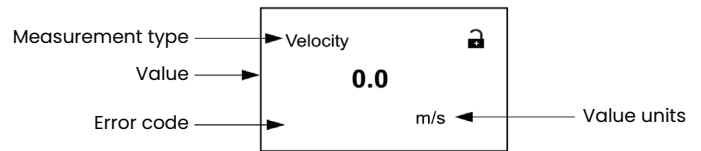
NOTE:

When both LEDs are off, the meter is either in *configuration mode* or *no power* is applied.

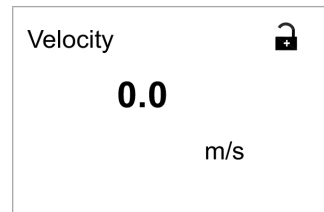


4.3.1 Changing the display for one- or two-variable screens

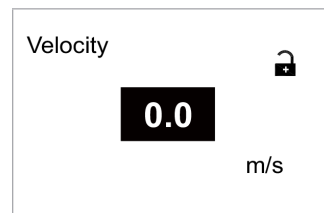
An outline of a typical one- or two-variable screen is shown below.



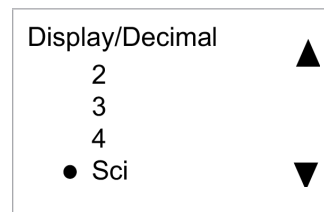
To change the number of decimal places in the displayed value:



From the display screen, press either the [◀] or [▶] keys until the value is highlighted.



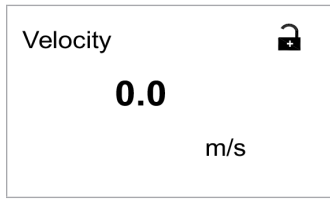
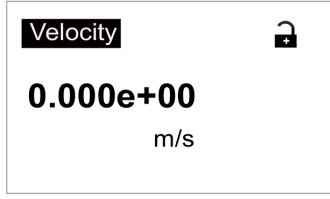
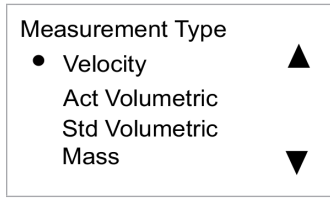
After the value is highlighted, press [v] to open the display/decimal option.



Use the [Δ] and [▽] keys to scroll to the desired value. (Available options include 0, 1, 2, 3, 4, and Sci (Scientific Notation)). Press [v] to select the value, and then press [v] again to confirm the selection or [✖] to cancel the selection.

4.3.2 Changing the measurement type for one- or two-variable screens

To change the measurement type:

	<p>From the display screen, press either the [\leftarrow] or [\rightarrow] keys until the measurement type is highlighted.</p>
	<p>After the value is highlighted, press [\checkmark] to open the measurement type option.</p>
	<p>The screen changes to display/measurement type. Press the [Δ] and [∇] keys to scroll to the desired parameter. Available parameters include: velocity, act volumetric, std volumetric, mass, batch totals, inventory totals, sound speed, Reynolds, KFactor, and diagnostics. After you have chosen the measurement type, press [\checkmark] to select the value, and then press [\checkmark] again to confirm the selection or [\times] to cancel the selection.</p>

NOTE:

To select a particular measurement unit, go to "Units setting."

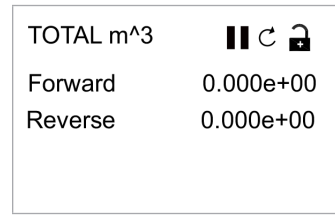
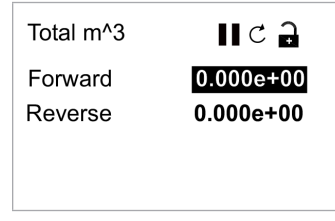
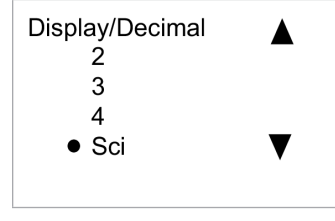
4.3.3 Changing the measurement type or units for the totalizer screens

The totalizer screen opens similar to figure 32 below.

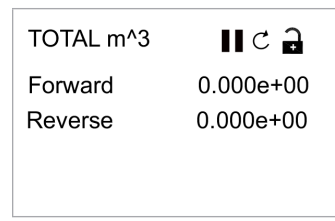
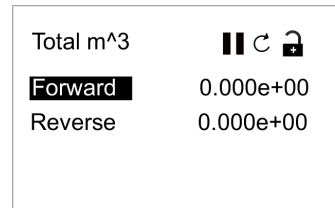


Figure 32: The totalizer screen

To change the number of decimal places in the value displayed on a totalizer screen, proceed as follows:

	<p>From the display screen, press either the [\leftarrow] or [\rightarrow] keys until the value is highlighted.</p>
	<p>After the value is highlighted, press [\checkmark] to open the display/decimal option.</p>
	<p>Use the [Δ] and [∇] keys to scroll to the desired number of decimal places. (Available options include 0, 1, 2, 3, 4, and Sci (Scientific Notation). Press [\checkmark] to select the value, and then press [\checkmark] again to confirm the selection or [\times] to cancel the selection.</p>

To change the totalizer measurement type, proceed as follows:

	<p>From the display screen, press either the [\leftarrow] or [\rightarrow] keys until the measurement type is highlighted.</p>
	<p>After the type is highlighted, press [\checkmark] to open the display/decimal option.</p>

Totalizer Type ▲

- Forward Totals
- Reverse Totals
- Net Totals
- Time ▼

The screen changes to totalizer type. Press the [△] and [▽] keys to scroll to the desired parameter. Available parameters include: forward totals, reverse totals, net totals and time. After you have chosen the type, press [√] to select the value, and then press [√] again to confirm the selection or [*] to cancel the selection.

If the first value is set to time, the meter displays the time unit. If the first value is set to forward totals, reverse totals, or net totals, the meter displays the selected unit in the *units setting* selection. The available time measurement units are seconds, minutes, hours or days. To choose the appropriate units, from the highlighted measurement type, press the [◀] or [▶] keys until the desired measurement unit is highlighted.

TOTAL **Seconds** || C 🔒

Time 0.0000

Reverse 0.000e+00

After the unit is highlighted, press [√] to open the display/unit option.

Display/Unit ▲

- Seconds
- Minutes
- Hours
- Days ▼

Press the [△] and [▽] keys to scroll to the desired units, and press [√] to select the unit, and then press [√] again to confirm the selection or [*] to cancel the selection.

NOTE:

If you selected *time*, the available units are seconds, minutes, hours and days.

4.3.4 Starting or stopping the totalizer measurement

To start or stop totalizer measurements:

TOTAL m^3 || C 🔒

Forward 0.000e+00

Reverse 0.000e+00

From the display, press either the [◀] or [▶] keys until the start/stop icon (either an arrow icon for start or a two-bar icon for stop) is highlighted.

TOTAL m^3 ||| C 🔒

Forward 0.000e+00

Reverse 0.000e+00

After the value is highlighted, press [√] to start or stop totalizing.

TOTAL m^3 ▶ C 🔒

Forward 0.000e+00

Reverse 0.000e+00

The display icon then changes to indicate the new status (start or stop).

4.3.5 Resetting the totalizer

To reset the totalizer, proceed as follows:

TOTAL m^3 || C 🔒

Forward 0.000e+00

Reverse 0.000e+00

From the display screen, press either the [◀] or [▶] keys until the reset icon (a partial circle with an arrow) is highlighted.

TOTAL m^3 ||| C 🔒

Forward 0.000e+00

Reverse 0.000e+00

After the reset icon has been highlighted, press [√] to reset the totalizer to 0.

4.4 Entering the main menu

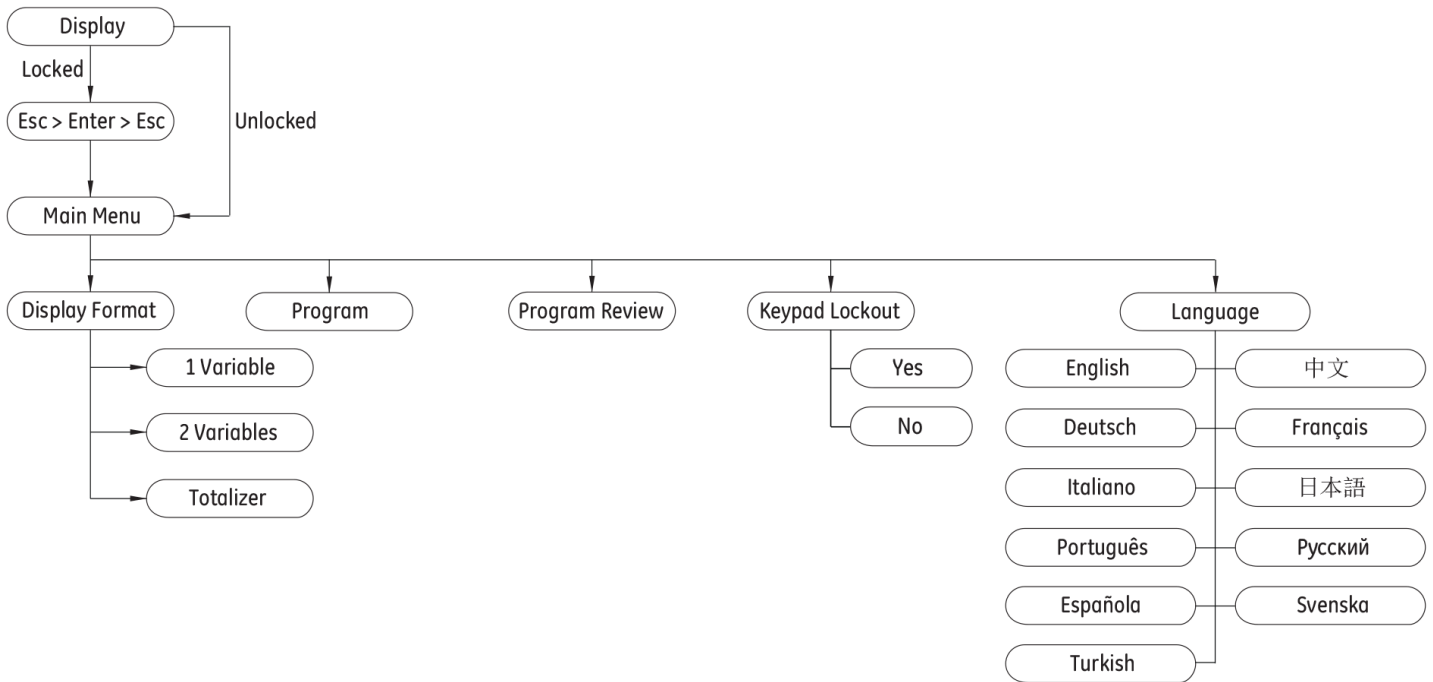
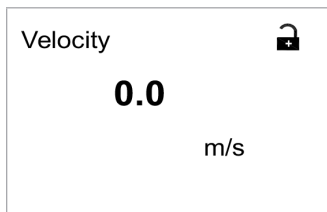


Figure 33: The main menu map

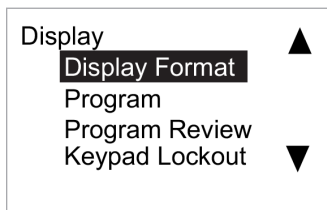
4.4.1 Display format

To begin programming your meter, you must select the system units as discussed below. Remember to record all programming data in Appendix B, *Data records*.

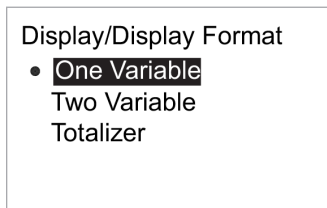
The display format submenu is used to set up the type of format to be used in displaying information.



On the initial screen, use the arrow keys to highlight the *lock symbol* and press [√]. The following screen opens.

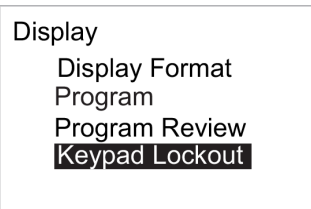


Use the [◀] or [▶] keys to highlight display format and press [√]. The following screen opens.



Use the [△] and [▽] arrow keys to highlight the desired format setup and press [√] to return to the previous screen.

4.4.2 Keypad lockout



To lock or unlock the keypad for security, on the display menu, select Keypad lockout and press [√]. A screen similar to the following opens.

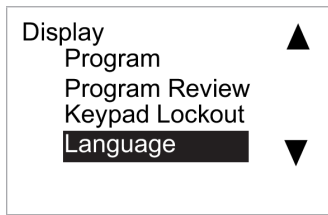


To lock the display, use the [△] and [▽] keys to highlight yes and press [√]. The screen returns to the previous display.
To unlock the display, use the [△] and [▽] keys to highlight no and press [√]. The screen returns to the previous display.

NOTE:

When the keypad is locked, press [✖], [√], [✖] to unlock it.

4.4.3 Language



To change the display language, on the display menu, select language and press [✓]. A screen similar to the following opens.



Use the [Δ] and [▽] arrow keys to highlight the desired language and press [✓] to return to the previous screen. The display language is changed to the new selection.

4.4.4 Program and program review menus

The program and program review menus allow setting up or viewing of several categories of information. As discussed, to edit parameters, you need to input a valid password. The

next section describes the access levels required to edit various parameters. To view all parameters without editing, select program review.

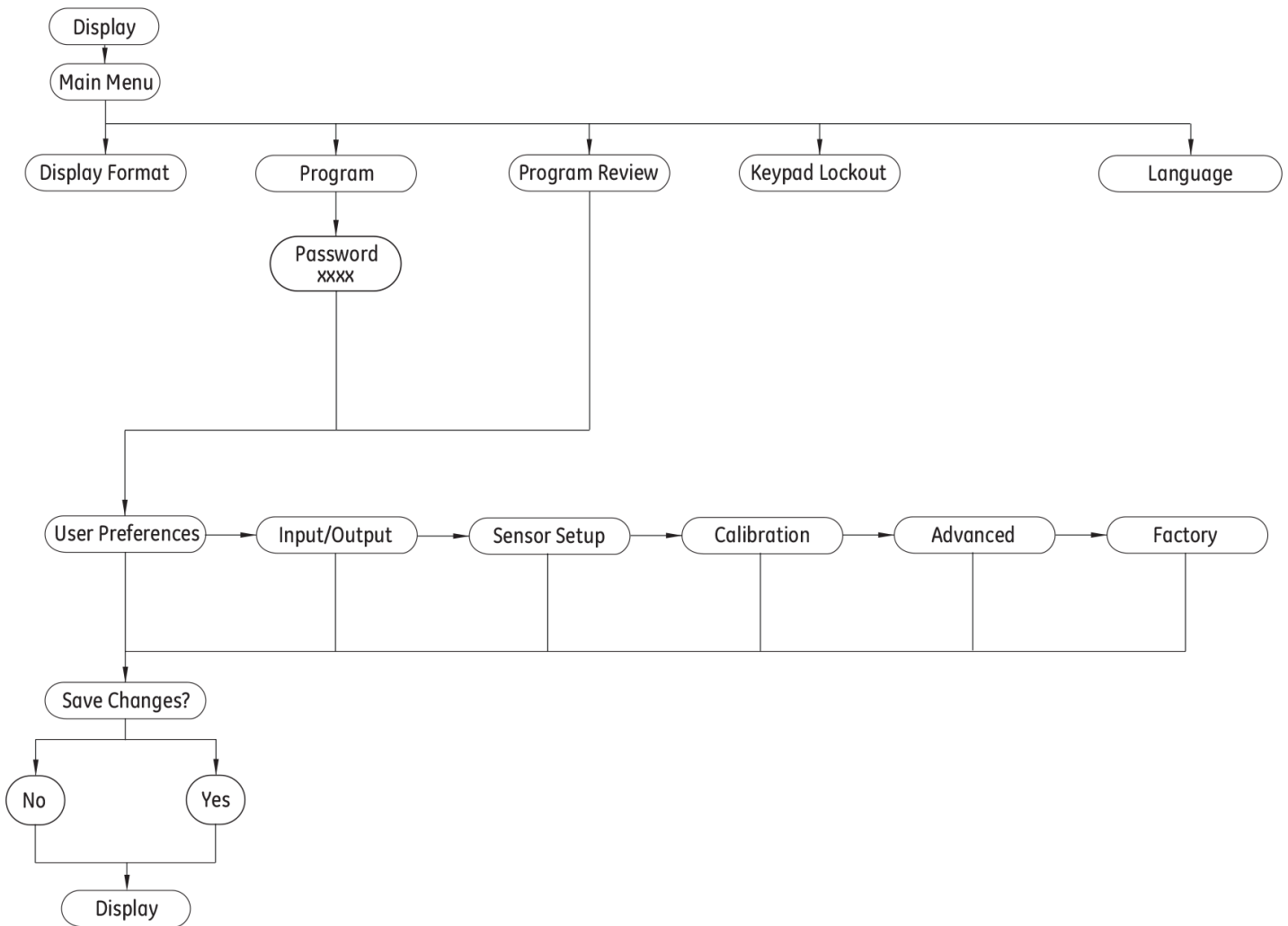


Figure 34: Program and program review menu map

4.4.4.1 Program review

The program review menu requires no user password. However, it provides view-only access to the information. To change any setting or parameter, you must enter the program menu by entering a valid password.

4.4.4.2 Program

IMPORTANT:

When you enter *program* (configure) mode, measurements stop and the output goes to error level.

Display

```
Display Format
Program
Program Review
Keypad Lockout
```

To enter the programming menu, on the display menu use the arrow keys to highlight program and press [√]. The following screen opens.

Enter the password

```
9999
[ x ]UNDO [ √ ]SAVE
[ ◀▶ ]MOVE [ ▲▼ ]MODF
```

Use the [◀] or [▶] key to select a specific digit, then use the [▲] or [▼] key to change that digit as required. After all digits are correct, press [√] to open the user preference screen.

NOTE:

The default password is **1111**.

4.5 User preferences

4.5.1 Setting

User Preference
Setting ▲
 Units Setting
 Density ▼
 Password ▼

To check or change the desired settings, under user preference, select settings and press [v]. The following screen opens.

Setting
Meter Tag
 Label
 System Date

To check the meter tag and/or Label, highlight your choice on the setting menu and press [v]. Press [*] to return to the previous screen.

NOTE:

You can only change the *meter tag* and *label* data using Panametrics' Vitality software.

Setting
 Meter Tag
 Label
System Date

To check or change the date/time, highlight system date and press [v]. The following screen opens.

Set System Time
 Date: 11 / 12 / 2013
 Time: 08 : 09 : 10
 [X]UNDO [✓]SAVE
 [◀▶]MOVE [▲▼]MODF

Use the [◀] or [▶] key to select a specific digit, then use the [Δ] or [∇] key to change that digit as required. After all digits are correct, press [v] to save. Then, press [*] to return to the previous screen.

4.5.2 Units setting

User Preference
 Settings ▲
Units Setting
 Density ▼
 Password ▼

To check or change velocity flow units, use the [Δ] or [∇] arrow key to select units setting and press [v]. The following screen opens.

Units Setting
Velocity ▲
 Act Volumetric
 Std Volumetric
 Mass ▼

Under units setting menu, use the [Δ] or [∇] arrow key to select the unit that need to be changed and press [v] to open the following screen.

NOTE:

Velocity is shown here as a typical example.

UnitsSet / Velocity
 • No
 Yes

If you don't want to change the selected unit, select no and press [v]. If you do want to change the selected unit, select yes, then press [v] twice to open the following screen.

UnitsSet /Velocity
 • English
 Metric

If no change is desired, press [*] twice to return to the units setting menu. To change the measurement system, select the desired option, press [v] twice to open a screen similar to the following.

Vel /
 • **Ft/s**

Confirm the selected units, press [*] three times to return to the units setting menu.

4.5.3 Density

User preference
Settings ▲
Units Setting
Density ▼
Password

To configure flow density, use the [Δ] or [▽] arrow key to select density and press [√]. The following screen opens.

Density
Density (Act)
Density (Std)

Use the [Δ] or [▽] arrow keys to highlight the desired density type and press [√].

Density
Density (Act)
1000.000 Kg/m³

Press [√] again and a screen similar to the following opens.

Density (Act)
UNIT: Kg/m³
1000.000
[x]UNDO [√]SAVE
[◀▶]MOVE [▲▼]MODF

Use the [◀] or [▶] key to select a specific digit, then use the [Δ] or [▽] key to change that digit as required. After all digits are correct, press [√] to save. Then, press [✖] to return to the previous screen.

4.5.4 Password

User preference
Setting ▲
Units Setting
Density
Password ▼

To set up a password, use the [Δ] or [▽] arrow key to select password and press [√]. The following screen opens.

Enter the password
9999
[x]UNDO [√]SAVE
[◀▶]MOVE [▲▼]MODF

Use the [◀] or [▶] key to select a specific digit, then use the [Δ] or [▽] key to change that digit as required. After all digits are correct, press [√] to save. Then, press [✖] to return to the previous screen.

The default password is 1111.

4.5.5 Display

4.5.5.1 Backlight

User preference
Units Setting ▲
Density
Password
Display ▼

To turn the backlight OFF or ON, use the [] or [▽] arrow key to select display and press [√]. The following screen opens.

Display
Backlight
Timeout

Select backlight, and press [√] to open a screen similar to the following.

Display/Backlight
● OFF
ON

Select OFF or ON, and press [√] twice to return to the previous screen.

4.5.5.2 Timeout

Display
Backlight
Timeout

To provide a timeout, select timeout and press [√]. A screen similar to the following opens.

NOTE:

The default value for the timeout is 0

Timeout
Timeout
19 S


Press [√] again, and a screen similar to the following opens.

Timeout
UNIT: S
19
[x]UNDO [√]SAVE
[◀▶]MOVE [▲▼]MODF

Use the [◀] or [▶] key to select a specific digit, then use the [△] or [▽] key to change that digit as required. After all digits are correct, press [√] to save. Then, press [*] three times to return to the user preference screen.

4.6 Inputs/outputs

4.6.1 Programming the analog output menu

Velocity 

0.0

m/s

To access the analog output menu, on the initial screen, highlight the lock symbol and press [v]. The following screen opens.

Display

Display Format

Program

Program Review

Keypad Lockout

Select program and press [v]. The following screen opens.

Enter the password


9999

[x] UNDO [✓] SAVE


[◀] MOVE [▶] MODF

Use the [◀] or [▶] key to select a specific digit, then use the [△] or [▽] key to change that digit as required. After all digits are correct, press [v] to save. The following screen opens.

User Preference

Settings 


Units Setting

Density 

Password


Select input/output and press the [▶] key. A screen similar to the following opens.

Input/Output

Analog Output A 

Digital Output B


Digital Output C

Modbus/Service Port 

Select the desired output with the [△] or [▽] arrow keys, and press [v] to enter the configuration menu.


4.6.1.1 Setting the analog measurements

Input/Output

Analog Output A 


Digital Output B

Digital Output C

Modbus/Service Port 


Select the desired output with the [△] or [▽] arrow keys, and press [v] to enter the configuration menu.

Analog Output A

Measurement 


Base Value

Full Value

Calibrate 


Select measurement and press [v]. The following screen opens.

Measurement

• **Velocity** 

Act Volumetric

Std Volumetric

Mass 

In the measurement menu, select the type of analog output to be used, and press [v] to return to the previous screen.

4.6.1.2 Setting the base value and the full value

Analog Output A
Measurement ▲
Base Value
Full Value
Calibrate ▼

Base value is the flow rate represented by a 4 mA output signal, and full value is the flow rate represented by a 20 mA output signal. In the analog output menu, select base value or full value and press [√]. A screen similar to the following opens.

Base Value
Base Value
0.0000 m/s

Press [√] again and a screen similar to the following opens.

NOTE:

The units shown are the units selected in the *units setting* menu.

Base Value
UNIT: m/s
0.0000
[x]UNDO [√]SAVE
[◀]MOVE [▶]MODF

Use the [◀] or [▶] key to select a specific digit, then use the [Δ] or [▽] key to change that digit as required. After all digits are correct, press [√] to save. Then, press [*] to return to the previous screen. Repeat these steps to set the full value setting, and press [*] to return to the analog output A menu.

4.6.1.3 Calibrate the output

Analog Output A
Measurement ▲
Base Value
Full Value
Calibrate ▼

Use the calibrate menu to trim the analog output. In the analog output menu, select calibrate and press [√]. A screen similar to the following opens.

Calibrate
• Calibrate 4mA
Calibrate 20mA
Percentage of Scale

Select either 4 mA to trim the 4 mA level, 20 mA to trim the 20 mA level, or percentage of scale to test the output linearity. Select the desired option and press [√]. A screen similar to the following opens.

Calibrate 4mA
UNIT: mA
4.000
[x]UNDO [√]SAVE
[◀]MOVE [▶]MODF

Read the analog output with a digital multimeter, and enter that value. Use the [◀] or [▶] key to select a specific digit, then use the [Δ] or [▽] key to change that digit as required. After all digits are correct, press [√] to save. Then, press [*] to return to the previous screen. Repeat these steps until the actual output value matches the programmed value.

4.6.1.4 Setting error handling


Analog Output A ▲
Base Value
Full Value
Calibrate
Error Handling ▼

To specify the error handling status in the analog output A menu, select error handling and press [√]. The following screen opens.

Calibrate
• **Low**
High
Hold
Other

During an error condition, selecting low forces the analog output to 3.6 mA or below, while selecting high forces it to 21.6 mA or above. HOLD keeps the last good value during an error condition. Select the desired setting and press [√].

4.6.2 Programming the digital output menu

Velocity 
0.0
m/s

To access the digital output menu, on the initial screen, highlight the lock symbol and press [√]. The following screen opens.

Display
Display Format
Program
Program Review
Keypad Lockout

Select program and press [√]. The following screen opens.

Enter the password
9999
[X]UNDO [√]SAVE
[◀▶]MOVE [▲▼]MODF

Use the [◀] or [▶] key to select a specific digit, then use the [▲] or [▼] key to change that digit as required. After all digits are correct, press [√] to save. Then, press [✱] to return to the previous screen.

User Preference
Settings ▲
Units Setting
Density ▼
Password ▼

In the user preference menu, select units setting and press the right arrow key. A screen similar to the following opens.

Input/Output ▲
Analog Output A
Digital Output B
Digital Output C
Modbus/Service Port ▼

Select the desired digital output with the [▲] or [▼] arrow keys, and press [√] to enter the relevant configuration menu.

NOTE:

The programming steps for digital output B and digital output C are the same as those for digital output A.

Digital outputs can be programmed as pulse, frequency or alarm, or they can be turned off.

4.6.2.1 Disable the digital output

Digital Output B

- **Off**
- Pulse
- Frequency
- Alarm

To disable digital output B, select off in the menu and press [✓] twice.

4.6.2.2 Setting the pulse output

Digital Output B

Off

- **Pulse**
- Frequency
- Alarm

The pulse output generates a square wave pulse for each unit of flow that passes through the pipeline. Select pulse and press [✓] to open the following screen.

Setting the measurement type

Pulse

- Measurement** ▲
- Pulse Value
- Pulse Time ▼
- Test Pulse

Select measurement and press [✓] to open the following screen.

Measurement

- **Forward Batch Total**
- Reverse Batch Total
- Net Batch Total

In the measurement menu, select the type of analog output to be used, and press [✓] to return to the previous screen.

Setting the pulse value

Pulse

- Measurement ▲
- Pulse Value**
- Pulse Time ▼
- Test Pulse

Use the [△] or [▽] arrow keys to select pulse value and press [✓]. A screen similar to the following opens.

Pulse Value

- Pulse Value**
- 10.0000 m³

The pulse value is the amount of flow represented by one pulse in the display. (e.g., 1 pulse = 10 m³.) To change the existing setting, press [✓] and a screen similar to the following opens.

NOTE:

The units shown are the units selected in the *units setting* menu.

Pulse Value

UNIT: m³

10.0000

[X]UNDO [✓]SAVE

[◀]MOVE [▶]MODF

Use the [◀] or [▶] key to select a specific digit, then use the [△] or [▽] key to change that digit as required. After all digits are correct, press [✓] to save. Then, press [✱] to return to the previous screen.

Setting the pulse time

Pulse

- Measurement ▲
- Pulse Value
- Pulse Time** ▼
- Test Pulse

Use the [△] or [▽] arrow keys to select pulse time and press [✓]. A screen similar to the following opens.

Pulse Time

- Pulse Time**
- 5 ms

The pulse time (i.e., the pulse width) is displayed. To change the existing setting, press [✓] and a screen similar to the following opens.

Pulse Time

UNIT: ms

5

[X]UNDO [✓]SAVE

[◀]MOVE [▶]MODF

Use the [◀] or [▶] key to select a specific digit, then use the [△] or [▽] key to change that digit as required. After all digits are correct, press [✓] to save. Then, press [✱] to return to the previous screen.

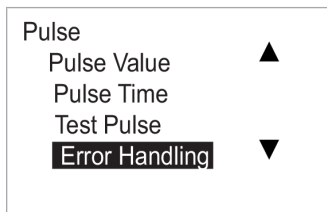
Totalizer pulse setting guidelines

When programming the pulse totalizer, a smaller pulse value generally results in higher totalizer accuracy. However, the minimum practical pulse value is limited by the resolution of the pulse counter being used. Thus, one must find the proper balance between the desire for a small pulse value and the capability of the pulse counter to accurately read the pulses output by the AT600.

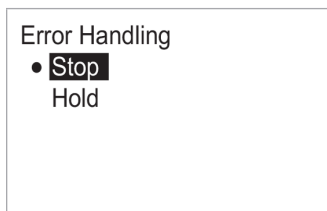
The best way to illustrate this process is with the following example calculation:

- The parameters set on the previous page are the **pulse value (PV = the volume of flow per pulse)** and the **pulse time (PT = the width of each pulse)**.
- Program the *pulse measurement as a forward batch totalizer*.
- Consider a process where the volumetric flow rate (**VR**) fluctuates near 4.6 liter/sec.
- As a typical value, try a PV of $VR/20 = 4.6/20$. Thus, set **PV = 0.23 liter/pulse**.
- Then, the duration of each pulse is $PV/VR = 0.23/4.6 = 50$ ms. As the pulse time (PT) is defined as half the pulse duration, then the correct **PT = 25 ms**.
- Program the AT600 frequency output with **PV = 0.23 liters/pulse** and **PT = 25 ms**. If your frequency counter correctly reads the AT600 pulse output, then these settings are appropriate. If not, you need to try different calculations for PV (instead of $VR/20$) until you find a set of values that can be properly read by your frequency counter. In general, the smallest PV value that is within the resolution specification for your frequency counter will provide the best accuracy for the batch totalizer.

Setting the pulse error handling

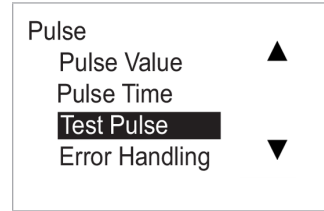


To change the error handling status of the pulse output, select error handling in the menu and press [√]. The following screen opens.

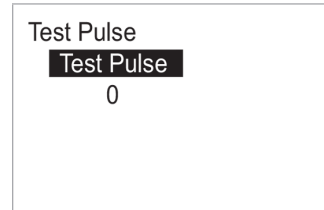


Select hold or stop. In case of a flow measurement error, hold directs the meter to keep sending the same pulses sent at the last good reading. Stop directs the meter to stop sending pulses during the error condition. Press [√] to return to the previous display or press [*] to return to the digital output menu.

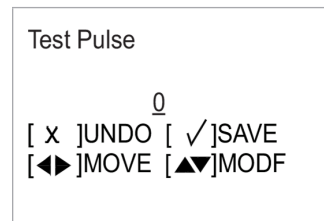
Test the pulse



To test the pulse output, select test pulse and press [√]. The following screen opens.



Press [√] to open a screen similar to the following. Press [√] again and the screen returns to the previous display. Press [*] to return to the digital output menu.



Use the [◀] or [▶] key to select a specific digit, then use the [△] or [▽] key to change that digit as required. After all digits are correct, press [√] to save. Verify on your frequency counter that the correct number of pulses were received. After testing is complete, press [*] to return to the digital output menu.

4.6.2.3 Setting the frequency

Digital Output B
Off
Pulse
• **Frequency**
Alarm

Frequency sends out a continuous square wave, with a frequency proportional to the measured flow rate. Select frequency and press [√] to open the following screen.

Setting measurement type

Frequency ▲
Measurement
Base Value
Full Value
Full Frequency ▼

Select measurement and press [√] to open a screen similar to the following.

Measurement ▲
• **Velocity**
Act Volumetric
Std Volumetric
Mass ▼

In the measurement menu, select the type of analog output to be used and press [√] to return to the previous screen.

Setting the base value, full value, and frequency

Frequency ▲
Measurement
Base Value
Full Value
Full Frequency ▼

The base value is the measurement that corresponds to a 0 Hz pulse. The full value is the measurement value that corresponds to a full frequency pulse. The full frequency is the maximum frequency used for the output pulse, and it indicates the maximum flow rate measurement. Use the [△] or [▽] arrow keys to select the appropriate option and press [√]. A screen similar to the following opens.

NOTE:

Use the same steps to program the *base value*, *full value* and *full frequency*.

Base Value
Base Value
0.0000 m/s

To change the existing number, press [√] and a screen similar to the following opens.

NOTE:

The units shown are the units selected in the *units setting* menu.

Base Value
UNIT: m/s
0.000
[x]UNDO [√]SAVE
[◀]MOVE [▶]MODF

Use the [◀] or [▶] key to select a specific digit, then use the [△] or [▽] key to change that digit as required. After all digits are correct, press [√] to save. Then, press [x] to return to the previous screen.

Setting the frequency error handling

```
Frequency
Full Value ▲
Full Frequency
Test Frequency
Error Handling ▼
```

To change the error handling status, select error handling in the menu and press [√]. The following screen opens.

```
Error Handling
• Low
High
Hold
Other
```

To change the current error handling status, select the desired option, and press [√]. The screen returns to the previous display.

There are four options for response to an error situation:

- **Hold:** hold the last good value
- **Low:** display 0 Hz
- **High:** display the full frequency
- **Other:** If selected, a screen similar to the following opens

```
Error Handling Value
Value
0 Hz
```

Enter the frequency value you want to display during an error situation. (e.g., if full frequency = 1 kHz, you may want to set the error handling value to 2 kHz.) Press [√] again, and a screen similar to the following opens.

```
Test Frequency
UNIT: Hz
0
[ x ]UNDO [ √ ]SAVE
[ ◀ ]MOVE [ ▶ ]MODF
```

Use the [◀] or [▶] key to select a specific digit, then use the [Δ] or [▽] key to change that digit as required. After all digits are correct, press [√] to save. Then, press [✱] to return to the previous screen.

The test frequency

```
Frequency
Full Value ▲
Full Frequency
Test Frequency
Error Handling ▼
```

To test the frequency output, select test frequency and press [√]. The following screen opens.

```
Test Frequency
Test Frequency
0 Hz
```

Press [√] to open a screen similar to the following.

```
Test Frequency
UNIT: Hz
0
[ x ]UNDO [ √ ]SAVE
[ ◀ ]MOVE [ ▶ ]MODF
```

Use the [◀] or [▶] key to select a specific digit, then use the [Δ] or [▽] key to change that digit as required. After all digits are correct, press [] to save. Then, verify at your frequency counter that you see the frequency you entered. If desired, you can repeat this procedure with several different frequencies. After testing is complete, press [✱] to return to the digital output menu.

4.6.2.4 Setting the alarm

Digital Output B
Off
Pulse
Frequency
• **Alarm**

The alarm can be either an open circuit (normally closed type) or a short circuit (normally open type), depending on the error condition. To check the alarm or change its settings, in the digital output menu select alarm and press [v]. The following screen opens.

Setting the alarm type

Alarm
Measurement ▲
Alarm State
Alarm Type
Alarm Value ▼

Use the [Δ] or [▽] arrow keys to select alarm type and press [v]. A screen similar to the following opens.

Setting the measurement type

Alarm
Measurement ▲
Alarm State
Alarm Type ▼
Alarm Value

Select measurement and press [v]. A screen similar to the following opens.

Measurement
• **Velocity** ▲
Act Volumetric
Std Volumetric
Mass ▼

In the measurement menu, select the type of analog output to be used, and press [v]. The screen returns to the previous display.

Alarm Type
• **Low**
High
Fault

You can choose from three alarm types:

- **Low:** the alarm trips only if the measurement falls to or below the threshold value
- **High:** the alarm trips if the measurement rises to or exceeds the threshold value
- **Fault:** the alarm trips only for system errors, such as a power failure

To change the type of alarm, select the desired type and press [v] to return to the previous screen.

Setting the alarm state

Alarm
Measurement ▲
Alarm State
Alarm Type ▼
Alarm Value

Use the [Δ] or [▽] arrow keys to select alarm state and press [v]. A screen similar to the following opens.

Alarm State
• **Normal**
Fail Safe

- Two alarm states are available:
- **Normal:** Normally open, the alarm contacts close in an error condition
 - **Fail safe:** Normally closed, the alarm contacts open upon in an error condition or a power failure

To change the state of the alarm, select the desired status and press [v].

The screen returns to the previous display.

Setting the alarm value

Alarm

- Alarm State ▲
- Alarm Type
- Alarm Value**
- Test Alarms ▼

The alarm value is the threshold that trips a low or high alarm. To check or change the alarm value, select alarm value and press [√]. A screen similar to the following opens.

Alarm Value

Alarm Value m/s

10.000

Press [√] again, and a screen similar to the following opens.

NOTE:

The units shown are the units selected in the *units setting* menu.

Alarm Value

UNIT: m/s

10.000

[X]UNDO [√]SAVE

[◀]MOVE [▶]MODF

Use the [◀] or [▶] key to select a specific digit, then use the [△] or [▽] key to change that digit as required. After all digits are correct, press [√] to save. Then, press [*] to return to the previous screen.

Test the alarms

Alarm

- Alarm State ▲
- Alarm Type
- Alarm Value
- Test Alarms** ▼

To test the alarms output, select test alarms and press [√]. The following screen opens.

Error Handling

- **OFF**
- ON

[X]UNDO [√]SAVE

Select OFF to disable the alarm or ON to enable the alarm. To begin testing, select ON and press [√]. To stop testing, press [*].

4.6.3 Programming the Modbus/service port

Input/Output

- Analog Output A ▲
- Digital Output B
- Digital Output C
- Modbus/Service Port** ▼

The Modbus/service port is configured at the factory as follows:

- **Baud rate** = 115200
- **Bits/parity** = 8/none
- **Stop bits** = 1
- **Address** = 1

To view the settings for the Modbus/service port, select it on the input/output screen and press [√].

4.6.4 Programming digital communications

The AT600 flow meter supports the following digital communication types:

- Modbus
- HART

A password is required to activate the digital communications options. In case of problems, contact Panametrics for assistance.

4.6.4.1 Modbus

```
Input/Output
Digital Output B ▲
Digital Output C
Modbus/Service Port
Digital Comm ▼
```

To set up Modbus, select digital comm on the input/output screen and press [√]. The following screen opens.

```
Digital Comm
MODBUS
```

Press [√] again, and a screen similar to the following opens.

Selecting the baud rate

```
MODBUS
Baud Rate
Address
Bits/Parity
Stop Bits
```

To set the baud rate, select baud rate and press [√]. A screen similar to the following opens.

```
Baud Rate
19200
38400
57600
• 115200
```

The default baud rate is 115200. To change the default, select the desired baud rate and press [√] to return to the previous screen.

Selecting the Modbus address

```
MODBUS
Baud Rate
Address
Bits/Parity
Stop Bits
```

To set the address, select Address and press [√]. A screen similar to the following opens.

```
Address
Address
1
```

Press [√] again, and a screen similar to the following opens.

```
Address
[ X ]UNDO1 [ √ ]SAVE
[ ◀▶ ]MOVE [ ▲▼ ]MODF
```

The default address is 1, but 1 to 254 are the acceptable values. Use the [◀] or [▶] key to select a specific digit, then use the [▲] or [▼] key to change that digit as required. After all digits are correct, press [√] to save. Then, press [✖] to return to the previous screen.

Selecting the bits/parity

```
MODBUS
Baud Rate
Address
Bits/Parity
Stop Bits
```

To set the bits/parity, select bits/parity and press [√]. A screen similar to the following opens.

```
Bits/Parity
8/None
8/Odd
• 8/Even
```

The default bits/parity is 8/none. Select the desired setting and press [√] to return to the previous screen.

Selecting the stop bits

MODBUS
Baud Rate
Address
Bits/Parity
Stop Bits

The default stop bits is 1.
To set the stop bits, select
stop bits and press [v].
A screen similar to the
following opens.

Stop Bits
• **1**
2

Select the desired setting
and press [v] to return to
the previous screen.

4.6.4.2 HART

Input/Output
Digital Output B ▲
Digital Output C
Modbus/Service Port
Digital Comm ▼

To set up HART
communication, select
digital comm on the
input/output screen and
press [v]. The following
screen opens.

NOTE:

Verify that the *HART* function is installed and activated on
your meter.

Digital Comm
HART

Press [v] again, and a
screen similar to the
following opens.

Setting the HART address

HART
Address

To set the HART address,
select address and press
[v]. A screen similar to the
following opens.

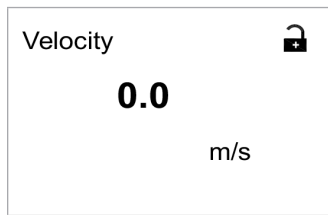
Address
Address
0

Press [v] again, and a
screen similar to the
following opens.

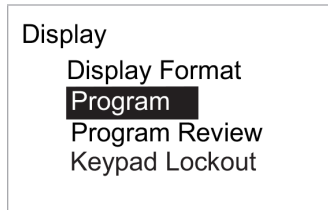
Address
0
[x]UNDO [√]SAVE
[◀▶]MOVE [▲▼]MODF

The default setting is 0.
Use the [◀] or [▶] key to
select a specific digit,
then use the [▲] or [▼]
key to change that digit
as required. After all digits
are correct, press [v] to
save. Then, press [*] to
return to the previous
screen.

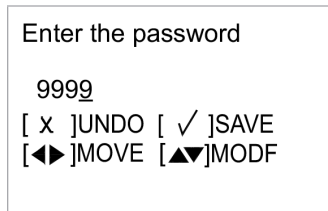
4.7 Sensor setup



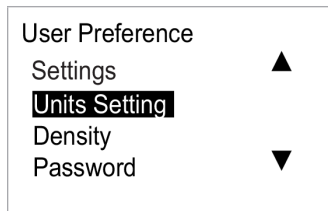
To access the sensor setup menu from the measurement display, highlight the lock symbol and press [√]. The following screen opens.



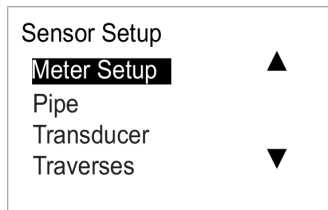
Select program and press [√]. The following screen opens.



Use the [◀] or [▶] key to select a specific digit, then use the [△] or [▽] key to change that digit as required. After all digits are correct, press [√] to save. Then, press [*] to return to the previous screen.



In the user preference menu, select units setting and press the [▶] key twice. A screen similar to the following opens.

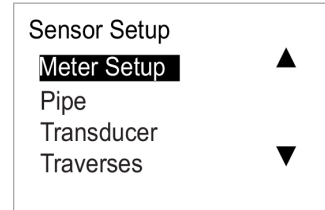


Select the desired parameter with the [△] or [▽] arrow keys, and press [√] to enter the configuration menu.

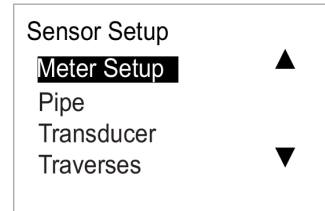
4.7.1 Meter setup

4.7.1.1 Setting the zero cutoff

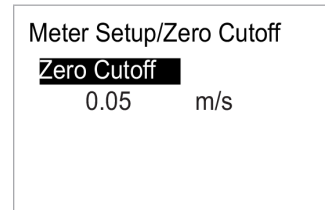
Near zero flow rate, the readings may fluctuate due to small offsets caused by thermal drift or similar factors. To force a zero display reading when there is minimal flow, enter a zero cutoff value as described below.



Select meter setup and press [√]. The following screen opens.



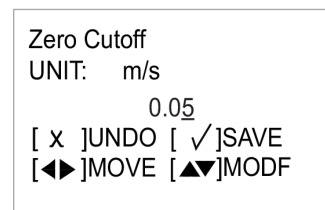
Select zero cutoff and press [√]. The following screen opens.



Press [√] again, and a screen similar to the following opens.

NOTE:

The units shown are the units selected in the *units setting* menu.



Use the [◀] or [▶] key to select a specific digit, then use the [△] or [▽] key to change that digit as required. After all digits are correct, press [√] to save. Then, press [*] to return to the previous screen.

4.7.2 Mounting type

4.7.2.1 Setting the mounting type

Sensor Setup Meter Setup ▲ Mounting Type Pipe ▼ Transducer	Select mounting type and press [√]. The following screen opens.	Mounting Type Clamp-on ▲ Wetted ▼	Select wetted if need and press [√] to return to the previous screen.
Mounting Type Clamp-on ▲ Wetted ▼	Select clamp-on if need and press [√] to return to the previous screen.		

4.7.3 Programming the pipe menu when wetted selected

4.7.3.1 Setting the pipe OD, ID, and wall thickness

Sensor Setup Meter Setup ▲ Mounting Type Pipe Transducer ▼	Select pipe and press [√]. The following screen opens.	Pipe OD UNIT: mm 89.760 x]UNDO [√]SAVE ◀▶]MOVE [▲▼]MODF	Use the [◀] or [▶] key to select a specific digit, then use the [▲] or [▼] key to change that digit as required. After all digits are correct, press [√] to save. Then, press [*] to return to the previous screen. Repeat these steps to enter the pipe ID and wall thickness. Then, press [*] to return to the pipe menu.
Pipe Pipe OD ▲ Pipe ID ▲ Wall Thickness ▼ Pipe Material ▼	In the sensor setup menu, select pipe OD, pipe ID or wall thickness and press [√]. A screen similar to the following opens.		
Pipe OD Pipe OD ▲ 89.760 mm ▼	Press [√] again, and a screen similar to the following opens.		

IMPORTANT:

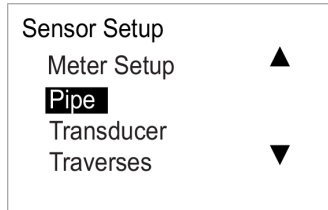
Changing the *pipe ID* (inside diameter) automatically changes the *wall* thickness. Similarly, changing the *wall* thickness automatically changes the *pipe ID*

NOTE:

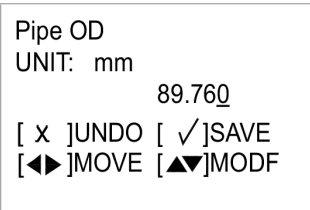
The units shown are the units selected in the *units setting* menu

4.7.4 Programming the pipe menu when clamp-on selected

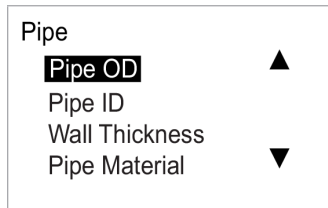
4.7.4.1 Setting the pipe OD, ID, and wall thickness



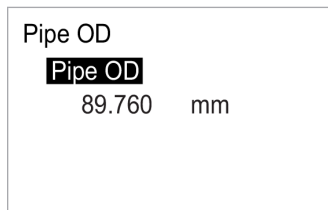
Select pipe and press [√]. The following screen opens.



Use the [◀] or [▶] key to select a specific digit, then use the [▲] or [▼] key to change that digit as required. After all digits are correct, press [√] to save. Then, press [✖] to return to the previous screen. Repeat these steps to enter the pipe ID and wall thickness. Then, press [✖] to return to the pipe menu.



In the sensor setup menu, select pipe OD, pipe ID or wall thickness and press [√]. A screen similar to the following opens.



Press [√] again, and a screen similar to the following opens.

IMPORTANT:

Changing the pipe ID (inside diameter) automatically changes *the* wall thickness. Similarly, changing the *wall* thickness automatically changes the *pipe ID*.

NOTE:

The units shown are the units selected in the *units setting* menu.

4.7.4.2 Selecting the pipe material

Pipe

Pipe OD ▲

Pipe ID

Wall Thickness ▼

Pipe Material ▼

In the pipe menu, select pipe material and press [√]. The following screen opens.

Pipe Material

CuNi

Glass

Plastic

• **Other**

Select the appropriate pipe material from the list, and press [✖] to return to the previous screen. If your pipe material is not listed, select other and press [√] twice. A screen similar to the following opens.

NOTE:

Table 3 below lists the available pre-programmed pipe materials.

Table 3:
Pre-programmed pipe materials

Name	Pipe material
CARBON STEEL	Carbon steel
SS STEEL	Stainless steel
DUCT IRON	Duct Iron
CAST IRON	Cast Iron
Cu	Cuprum
Al	Aluminum
BRASS	Brass
30%Ni	30% nickel copper alloy
10%Ni	10% nickel copper alloy
PYREX GLASS	Pyrex glass
FLINT GLASS	Flint glass
CROWN GLASS	Crown glass
NYLON PLSTC	Nylon plastic
POLYE PLSTC	Polyethylene
POLYP PLSTC	Polypropylene
PVC PLSTC	Polyvinyl chloride
ACRYL PLSTC	Acrylic plastic

Pipe SOS

Pipe SOS

2400.000 m/s

Press [√] again, and a screen similar to the following opens.

NOTE:

The units shown are the units selected in the *units setting* menu.

Pipe SOS

UNIT: m/s

2400.000

[x]UNDO [√]SAVE

[◀▶]MOVE [▲▼]MODF

Use the [◀] or [▶] key to select a specific digit, then use the [▲] or [▼] key to change that digit as required. After all digits are correct, press [√] to save. Then, press [✖] to return to the previous screen.

4.7.4.3 Setting the pipe lining

```

Pipe
  Pipe ID      ▲
  Wall Thickness
  Pipe Material
  Lining      ▼
  
```

In the pipe menu, select lining and press [√]. The following screen opens.

```

Lining
  No
  • Yes
  
```

If there is no lining in your pipe, select no and press [√] to return to the previous screen. If your pipe does have a lining, select yes and press [√] twice. A screen similar to the following opens.

```

Lining
  Lining Thickness
  Lining Material
  
```

To set the lining thickness, select lining thickness and press [√]. A screen similar to the following opens.

```

Lining Thickness
  Lining Thickness
  0.000 mm
  
```

Press [√] again, and a screen similar to the following opens.

NOTE:

The units shown are the units selected in the *units setting* menu

```

Lining Thickness
UNIT: mm
  0.000
[ x ]UNDO [ √ ]SAVE
[ ◀ ]MOVE [ ▶ ]MODF
  
```

Use the [◀] or [▶] key to select a specific digit, then use the [Δ] or [▽] key to change that digit as required. After all digits are correct, press [√] to save. Then, press [✖] to return to the previous screen.

```

Lining Material
  MORTR
  RUBBR
  REFLN
  • Other
  
```

Select lining material and press [√], then select the appropriate option and press [√]. If your pipe material is not listed (see table 4 below for the available options), select other and press [√] twice. A screen similar to the following opens.

Table 4:
Pre-programmed pipe lining materials

Name	Lining material
Tar epoxy	Tar epoxy
Pyrex glass	Pyrex glass
Asbestos cement	Asbestos cement
Mortar	Mortar
Rubber	Rubber
Teflon	Teflon (PFTE)

```

Lining SOS
  Lining SOS
  2000.000 m/s
  
```

Press [√] again, and a screen similar to the following opens.

NOTE:

The units shown are the units selected in the *units setting* menu.

```

Lining SOS
UNIT: m/s
  2000.000
[ x ]UNDO [ √ ]SAVE
[ ◀ ]MOVE [ ▶ ]MODF
  
```

Use the [◀] or [▶] key to select a specific digit, then use the [Δ] or [▽] key to change that digit as required. After all digits are correct, press [√] to save. Then, press [✖] to return to the previous screen.

4.7.5 Programming the transducer when clamp-on selected

4.7.5.1 Entering a standard transducer

<p>Sensor Setup Meter Setup ▲ Pipe Transducer Traverses ▼</p>	<p>Select transducer and press [√]. The following screen opens.</p>
<p>Transducer ● STD SPEC</p>	<p>Select STD and press [√]. A screen similar to the following opens.</p>
<p>STD STD 0</p>	<p>Press [√] again, and a screen similar to the following opens.</p>
<p>STD 0 [x]UNDO [√]SAVE [◀]MOVE [▶]MODF</p>	<p>Use the [◀] or [▶] key to select a specific digit, then use the [△] or [▽] key to change that digit as required. After all digits are correct, press [√] to save. Then, press [✖] to return to the previous screen.</p>

NOTE:

The available AT600 standard transducers are listed in table 5 below.

Table 5:
Standard transducer types

Transducer number	Transducer type
10	CPT-0.5CPT-0.5
11	CPT-2.0
12	CPT-0.5-MT C-PB-05-M
13	CPT-1.0-MT C-PB-10-M
14	CPT-2.0-MT C-PB-20-M
15	CPT-0.5-HT
16	CPT-1.0-HT
17	CPT-2.0-HT
18	CPS-0.5
19	CPSM-2.0
20	CTS-1.0
21	CTS-1.0-HT
22	CTS-2.0
23	C-LP-40-HM
24	C-LP-40-NM
25	CPB-0.5-HT
26	CPB-2.0-MT
27	CPB-0.5-MT
28	CPB-2.0
29	CPB-0.5
30	CPS-1.0 CPT-1.0
31	CWL-2

**Table 5:
Standard transducer types**

Transducer number	Transducer type
32	CPS-1.0
33	CPW (WT-IP-1.0 on AB82)
34	CPW (WT-IP-0.5 on NDT plastic)
35	CPW (WT-IP-1.0 on NDT plastic)
36	CPB-1.0-HT
37	CPB-2.0-HT
38	CPB-1.0
39	CPB-1.0-MT
301	C-RL-0.5
302	C-RL-1
304	C-RL-0.5
305	C-RL-1
307	C-RL-0.5
308	C-RL-1

**Table 5:
Standard transducer types**

Transducer number	Transducer type
310	C-RV-0.5
311	C-RV-1
313	C-RW-0.5
314	C-RW-1
401	C-RS-0.5 ¹
402	C-RS-1 ¹
403	C-RS-2
407	UTXDR-2
408	UTXDR-5
601	CAT-0.5
602	CAT-1
603	CAT-2 ¹

¹ Currently supported transducer

4.7.5.2 Entering a special transducer

<p>Sensor Setup Meter Setup ▲ Mounting Type Pipe Transducer ▼</p>	<p>Select transducer and press [√]. The following screen opens.</p>	<p>Special Transducer Frequency ▲ Wedge Angle Wedge SNSD ▼ Time Wedge</p>	<p>Select wedge SNSD and press [√]. The following screen opens.</p>
<p>Transducer STD • SPEC</p>	<p>Select SPEC and press [√]. A screen similar to the following opens.</p>	<p>Wedge SNSD Wedge SNSD 2482 m/s</p>	<p>Press [] again, and a screen similar to the following opens.</p>
<p>Special Transducer Frequency ▲ Wedge Angle Wedge SNSD ▼ Time Wedge</p>	<p>In the special transducer menu, select frequency and press [√]. The following screen opens.</p>	<p>Wedge SOS UNIT: m/s 2482 [x]UNDO [√]SAVE [◀▶]MOVE [▲▼]MODF</p>	<p>Use the [] or [] key to select a specific digit, then use the [] or [] key to change that digit as required. After all digits are correct, press [] to save. Then, press [] to return to the previous screen.</p>
<p>Frequency 0.5 Mhz • 1 Mhz 2 Mhz 4 Mhz</p>	<p>Select the appropriate option and press [√] twice to return to the previous screen.</p>	<p>Special Transducer Wedge Type ▲ Wedge Angle Wedge SOS Time Wedge ▼</p>	<p>Select time wedge and press [√]. The following screen opens.</p>
<p>Special Transducer Frequency ▲ Wedge Angle ▼ Wedge SNSD Time Wedge</p>	<p>Select wedge angle and press [√]. The following screen opens.</p>	<p>Time Wedge Time Wedge 7.500 us</p>	<p>Press [√] again, and a screen similar to the following opens.</p>
<p>Wedge Angle Wedge Angle 42</p>	<p>Press [√] again, and a screen similar to the following opens.</p>	<p>Time Wedge UNIT: us 7.500 [x]UNDO [√]SAVE [◀▶]MOVE [▲▼]MODF</p>	<p>Use the [◀] or [▶] key to select a specific digit, then use the [△] or [▽] key to change that digit as required. After all digits are correct, press [√] to save. Then, press [✱] to return to the previous screen.</p>
<p>Wedge Angle 42 [x]UNDO [√]SAVE [◀▶]MOVE [▲▼]MODF</p>	<p>Use the [◀] or [▶] key to select a specific digit, then use the [△] or [▽] key to change that digit as required. After all digits are correct, press [√] to save. Then, press [✱] to return to the previous screen.</p>		

4.7.6 Programming the transducer when wetted selected

4.7.6.1 Entering a standard transducer

<p>Sensor Setup ▲ Meter Setup ▲ Pipe Transducer Traverses ▼</p>	<p>Select transducer and press [v]. The following screen opens.</p>
<p>Transducer ● STD SPEC</p>	<p>Select STD and press [v]. A screen similar to the following opens.</p>
<p>STD STD 0</p>	<p>Press [v] again, and a screen similar to the following opens.</p>
<p>STD 0 [x]UNDO [✓]SAVE [◀▶]MOVE [▲▼]MODF</p>	<p>Use the [◀] or [▶] key to select a specific digit and change that digit as required. After all digits are correct, press [v] to save. Then, press [x] to return to the previous screen.</p>

Table 6:
Standard wetted transducer types

Transducer number	Transducer type
40	WT-1/IP-10-00-NT
44	WT-1/IP-05-00-NT
71	PA-36-1P/WT-1/IP-10-00
72	PA-36-1P/WT-1/IP-10-00-HL
73	PA-PV-1P or F/WT-1/IP-10-EW
74	PA-36-1P-EW/WT-1/IP-10
75	PA-36-1P-EW/WT-1/IP-10-00-HL

NOTE:

The available AT600 standard transducers are listed in table 6 below.

4.7.6.2 Entering a special transducer

<p>Sensor Setup Meter Setup ▲ Pipe Transducer Traverses ▼</p>	<p>Select transducer and press [√]. The following screen opens.</p>	<p>Special Transducer Frequency ▲ Time Wedge ▼</p>	<p>Select time wedge and press [√]. The following screen opens.</p>
<p>Transducer STD ● SPEC</p>	<p>Select SPEC and press [√]. A screen similar to the following opens.</p>	<p>Time Wedge Time Wedge us 7.500</p>	<p>Press [√] again, and a screen similar to the following opens.</p>
<p>Special Transducer Frequency ▲ Time Wedge ▼</p>	<p>In the special transducer menu, select frequency and press [√]. The following screen opens.</p>	<p>Time Wedge UNIT: us 7.500 [x]UNDO [√]SAVE [◀▶]MOVE [▲▼]MODF</p>	<p>Use the [◀] or [▶] key to select a specific digit, then use the [▲] or [▼] key to change that digit as required. After all digits are correct, press [√] to save. Then, press [*] to return to the previous screen.</p>
<p>Frequency 0.5 Mhz ● 1 Mhz 2 Mhz 4 Mhz</p>	<p>Select the appropriate option and press [√] twice to return to the previous screen.</p>		

4.7.7 Programming the number of traverses

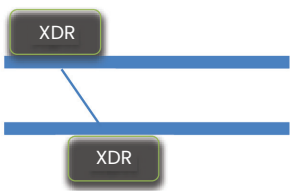
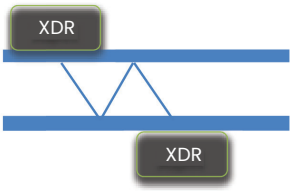
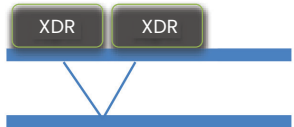
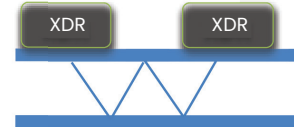
<p>1 Traverse</p> 	<p>3 Traverse</p> 	<p>Sensor Setup Meter Setup ▲ Pipe Transducer Traverses ▼</p>	<p>Select traverses and press [√]. The following screen opens.</p>
<p>2 Traverse</p> 	<p>4 Traverse</p> 	<p>Traverses 1 ● 2 3 4</p>	<p>Select the appropriate option and press [√] to return to the previous screen.</p>

Figure 35: Examples of 1 to 4 traverses

4.7.8 Programming the fluid type

If the *fluid type* is known, the meter performs flow rate calculations based on the programmed parameters for that fluid. However, if the fluid type is not known, you must activate the tracking windows function described below. Relocating the transducers is not necessary.

Sensor Setup
Traverses ▲
Fluid Type
Fluid Temperature
Transducer Spacing ▼

Select fluid type and press [v]. The following screen opens.

Fluid Type
Water
• Other

If the fluid type is water, select water and press [v] to return to the previous screen.

If the fluid is not water, select other and press [v]. A screen similar to the following opens.

Tracking Window
No
• Yes

To disable the tracking window, select no and press [v]. A screen similar to the following opens, so that you can enter the speed of sound (fluid SOS.) in your fluid. If you don't know your fluid SOS, you should enable the tracking window so that the meter can detect it automatically. If the tracking window is enabled, select Yes and press [v]. A screen similar to the following opens. Enter the maximum SOS and minimum SOS.

Fluid SOS
Fluid SOS
1496.000 m/s

Press [v] again, and a screen similar to the following opens.

Fluid SOS
UNIT: m/s
1496.000
[x] UNDO [v] SAVE
[◀] MOVE [▲] MODF

Use the [◀] or [▶] key to select a specific digit, then use the [△] or [▽] key to change that digit as required. After all digits are correct, press [v] to save. Then, press [x] to return to the previous screen.

NOTE:

Fluid SOS, maximum SOS and minimum SOS are all programmed in the same manner.

4.7.9 Programming the fluid temperature

```
Sensor Setup
Traverses      ▲
Fluid Type
Fluid Temperature
Transducer Spacing ▼
```

Select fluid temperature in the sensor setup menu, and press [√]. The following screen opens.

```
Fluid Temperature
Fluid Temperature
25.000 °C
```

Press [√] again, and a screen similar to the following opens.

```
Fluid Temperature
UNIT: °C
25.000
[ x ]UNDO [ √ ]SAVE
[ ◀ ]MOVE [ ▶ ]MODF
```

Use the [◀] or [▶] key to select a specific digit, then use the [Δ] or [▽] key to change that digit as required. After all digits are correct, press [√] to save. Then, press [*] to return to the previous screen.

NOTE:

Because the meter calculations are based on customer inputs, the fluid temperature affects the speed of sound used during a measurement.

4.7.10 Calculating the path when clamp-on selected

```
Sensor Setup
Traverses      ▲
Fluid Type
Fluid Temperature
Transducer Spacing ▼
```

Select path and press [√]. The following screen opens.

```
Transducer Spacing
Transducer Spacing
0.000 mm
```

Press [√] again. Record this calculated transducer spacing for use in installing your transducers on the pipe. The calculation is based on your sensor setup input (pipe, transducer, fluid, and transducers).

NOTE:

If setting the calculated spacing for your transducers is not possible, contact the factory for assistance. Only if instructed by the factory, press [√] again, and a screen similar to the following opens.

```
Transducer Spacing
UNIT: mm
0.000
[ x ]UNDO [ √ ]SAVE
[ ◀ ]MOVE [ ▶ ]MODF
```

Use the [◀] or [▶] key to select a specific digit, then use the [Δ] or [▽] key to change that digit as required. After all digits are correct, press [√] to save. Then, press [*] to return to the previous screen.

IMPORTANT:

Changing the transducer spacing should only be completed according to instructions received from the factory.

4.7.11 Enter the path when wetted selected

Sensor Setup
Traverses ▲
Fluid Type
Fluid Temperature
Transducer Spacing ▼

Select path and press [√]. The following screen opens.

Path
Path Length ▲
Axial Length ▲
▼

In the sensor setup menu, select path length or axial length and press [√]. A screen similar to the following opens.

Path
Path Length ▲
0.000 mm ▼

Press [√] again. Enter this path use in installing your transducers on the pipe. The calculation is based on your sensor setup input (pipe, transducer, fluid, and traverses).

Path Length
UNIT: mm
0.000
x]UNDO [√]SAVE
◀▶]MOVE [▲▼]MODF

Use the [◀] or [▶] key to select a specific digit, then use the [▲] or [▼] key to change that digit as required. After all digits are correct, press [√] to save. Then, press [x] to return to the previous screen.

IMPORTANT:

Changing the transducer spacing should only be completed according to instructions received from the factory.

Chapter 5. Error codes and troubleshooting

5.1 Error display in the user interface

The bottom line of the LCD displays a single, top priority error message during operation. This line, called the *error line*, includes two parts: *error header* and *error string*. The error header indicates the error pattern and error number, while the error string gives a detailed description of the error information.

5.1.1 Error header

Error pattern	Error header
Flow error	En (n is error number)
Device error	Dn (n is error number)
Warning	Sn (n is error number)

5.1.2 Flow error string

Flow errors are errors that occur during a flow measurement. These errors can be caused by disturbances in the fluid, such as excessive particles in the flow stream or extreme temperature gradients. The errors could also be caused by

an empty pipe or other such issue. Flow errors are typically not caused by a malfunction of the flow measurement device, but by a problem with the fluid itself or with the process piping.

Option Bar	Description	Good	Bad
Tup	Displays the upstream ultrasonic signal transit time.	NA	NA
Tdn	Displays the downstream ultrasonic signal transit time.	NA	NA
DeltaT	Displays the transit time difference between the upstream and downstream signals.	NA	NA
Up signal quality	Displays the signal quality for the upstream transducer.	≥ 1200	< 400
Dn signal quality	Displays the signal quality for the downstream transducer.	≥ 1200	< 400
Up amp disc	Displays the value for the signal amplitude of the upstream transducer.	24 ± 5	< 19 or > 29
Dn amp disc	Displays the value for the signal amplitude of the downstream transducer.	24 ± 5	< 19 or > 29
SNR up	Display the value for the signal-to-noise of the upstream signal.	≥ 4	< 4
SNR Dn	Display the value for the signal-to-noise of the downstream signal.	≥ 4	< 4
Gain up	Display the value for the gain of the upstream transducer.	9-85	< 9 or > 85
Gain Dn	Display the value for the gain of the downstream transducer.	9-85	< 9 or > 85
Up peak	Displays the first value in the upstream correlation signal, which is more than the positive threshold or is less than the negative threshold.	NA	NA
Dn peak	Displays the first value in the downstream correlation signal, which is more than the positive threshold or is less than the negative threshold.	NA	NA
PeakPctUp	Displays the percentage of peak of the upstream signal.	NA	NA
PeakPctDn	Displays the percentage of peak of the downstream signal.	NA	NA

5.1.2.1 E1: Low signal

- Problem:** Poor ultrasonic signal strength or the signal exceeds the programmed limit.
- Cause:** When the SNR is less than the value of signal low limit or the signal cannot be found when the flow is started, the low signal error is displayed. Poor signal strength may be caused by a defective cable, a flowcell problem, a defective transducer or a problem in the electronics console. A signal that exceeds the programmed limits is probably caused by the entry of an improper value in the menu program > advanced > error limits > signal low limits.
- Action:** Refer to “*Diagnostics*.” Also, check the programmed value in the menu program > advanced > error limits > signal low limit menu.

5.1.2.2 E2: Sound speed error

- Problem:** The sound speed exceeds the limit programmed in the menu program > advanced > error limits > SNSD+- limit menu.
- Cause:** When the measured sound speed exceeds the programmed sound speed limit, this error is displayed. The error may result from incorrect programming, poor flow conditions, and/or poor transducer orientation.
- Action:** Correct the programming errors. Refer to “*Diagnostics*” to correct the flowcell and/or transducer problems. Also, check the value programmed in the menu program > advanced > error limits SNSD +- limit menu.

5.1.2.3 E3: Velocity range

- Problem:** The velocity exceeds the limits programmed in the menu program > advanced > error limits velocity low/high menu.
- Cause:** When the measured velocity exceeds the programmed velocity limit, this error is displayed. The error may be caused by improper programming, poor flow conditions, and/or excessive flow turbulence.
- Action:** Make sure the actual flow rate is within the programmed limits. Also, check the value programmed in the menu program > advanced > error limits > velocity low/high menu. Refer to “*Diagnostics*” to correct the flowcell and/or transducer problems.

5.1.2.4 E4: Signal quality

- Problem:** The signal quality is outside the limits programmed in the menu program > advanced > error limits correlation peak menu.
- Cause:** The peak of the upstream or downstream correlation signals has fallen below the correlation peak limit programmed in the menu program > advanced > error limits > correlation peak menu. This may be caused by a flowcell or electrical problem.
- Action:** Check for sources of electrical interference and verify the integrity of the electronics console by temporarily substituting a test flowcell that is known to be good. Check the transducers and relocate them, if necessary. See “*Diagnostics*” for instructions.

5.1.2.5 E5: Amplitude error

- Problem:** The signal amplitude exceeds the limits programmed in the menu program > advanced > error limits amp disc min/max menu.
- Cause:** Solid or liquid particulates may be present in the flowcell. Also, poor coupling for the clamp-on transducers can cause this problem.
- Action:** Refer to “*Diagnostics*” to correct any flowcell problems.

5.1.2.6 E6: Cycle skip

- Problem:** The fluid acceleration exceeds the limits programmed in the menu program > advanced > error limits acceleration menu.
- Cause:** This condition is usually caused by poor flow conditions or improper transducer alignment.
- Action:** Refer to “*Diagnostics*” to correct any flowcell and/or transducer problems.

5.2 Diagnostics

5.2.1 Introduction

This section explains how to troubleshoot the AT600 if problems arise with the electronics enclosure, the flowcell, or the transducers. Indications of a possible problem include:

- Display of an error message on the LCD display screen, Vitality PC software, or HART.
- Erratic flow readings

- Readings of doubtful accuracy (i.e., readings that are not consistent with readings from another flow measuring device connected to the same process).

If any of the above conditions occurs, proceed with the instructions presented in this section.

5.2.2 Flowcell problems

If preliminary troubleshooting of an *error code* display indicates a possible flowcell problem, proceed with this section. Flowcell problems fall into two categories: *fluid problems* or *pipe problems*. Read the following sections carefully to determine if the problem is indeed related to the flowcell. If the instructions in this section fail to resolve the problem, contact Panametrics for assistance.

5.2.2.1 Fluid problems

Most fluid-related problems result from a failure to observe the flow meter system installation instructions. Refer to Chapter 2, *Installation*, to correct any installation problems.

If the physical installation of the system meets the recommended specifications, it is possible that the fluid itself may be preventing accurate flow rate measurements. The fluid being measured must meet the following requirements:

- *The fluid must be homogeneous, single-phase, relatively clean and flowing steadily.*
 - Although a low level of entrained particles may have little effect on the operation of the AT600, excessive amounts of solid or gas particles will absorb or disperse the ultrasound signals. This interference with the ultrasound transmissions through the fluid causes inaccurate flow rate measurements. In addition, temperature gradients in the fluid may result in erratic or inaccurate flow rate readings.

- *The fluid must not cavitate near the flowcell.*
 - Fluids with a high vapor pressure may cavitate near or in the flowcell. This causes problems resulting from gas bubbles in the fluid. Cavitation can usually be controlled through proper installation procedures.
- *The fluid must not excessively attenuate ultrasound signals.*
 - Some fluids, particularly those that are very viscous, readily absorb ultrasound energy. In such cases, an E1 error code message appears on the display screen to indicate that the ultrasonic signal strength is insufficient for reliable measurements.
- *The fluid sound speed must not vary excessively.*
 - The AT600 will tolerate relatively large changes in the fluid sound speed, as may be caused by variations in fluid composition and/or temperature. However, such changes must occur slowly. Rapid fluctuations in the fluid sound speed, to a value that exceeds the limit programmed into the AT600, will result in erratic or inaccurate flow rate readings. Refer to Chapter 3, Initial setup and programming, and make sure that the appropriate sound speed limit is programmed into the meter.

5.2.2.2 Pipe problems

Pipe-related problems may result either from a failure to observe the installation instructions, as described in Chapter 2, *Installation*, or from improper programming of the meter. By far, the most common pipe problems are the following:

- *The collection of material at the transducer location(s).*
 - Accumulated debris at the transducer location(s) will interfere with transmission of the ultrasound signals. As a result, accurate flow rate measurements are not possible. Realignment of the flowcell or transducers often cures such problems, and in some cases, transducers that protrude into the flow stream may be used. Refer to Chapter 2, *Installation*, for more details on proper installation practices.
- *Inaccurate pipe measurements.*
 - The accuracy of the flow rate measurements is no better than the accuracy of the programmed pipe dimensions. For a flowcell supplied by Panametrics, the correct data will be included in the documentation. For other flowcells, measure the pipe wall thickness and diameter with the same accuracy desired in the flow rate readings. Also, check the pipe for dents, eccentricity, weld deformity, straightness and other factors that may cause inaccurate readings. Refer to Chapter 3, *Initial setup*, for instructions on programming the pipe data.

In addition to the actual pipe dimensions, the path length (P) and the axial dimension (L), based on the actual transducer mounting locations, must be accurately programmed into the flow meter. For a Panametrics flowcell, this data will be included with the documentation for the system. If the transducers are mounted onto an existing pipe, these dimensions must be precisely measured.

- *The inside of the pipe or flowcell must be relatively clean.*
 - Excessive buildup of scale, rust or debris will interfere with flow rate measurement. Generally, a thin coating or a solid well-adhered build up on the pipe wall will not cause problems. Loose scale and thick coatings (such as tar or oil) will interfere with ultrasound transmission and may result in incorrect or unreliable measurements.

Chapter 6. Communication

6.1 MODBUS

6.1.1 Introduction

The AT600 flow meter generally follows the standard MODBUS communications protocol defined by the **MODBUS APPLICATION PROTOCOL SPECIFICATION V1.1b**, which is available at www.modbus.org. With this reference as a guide, an operator can use any MODBUS master to communicate with the AT600 flow meter.

For the AT600, there are two limits of this implementation:

1. The AT600 supports only four of the standard function codes. These are read holding registers (0x03), read input registers (0x04), write multiple registers (0x10), and read file record (0x14).
2. The AT600 needs a 15 ms gap between Modbus requests. The prime objective of the flow meter is to measure flow and drive the output, so the Modbus server has a low priority.

6.1.2 MODBUS register map

Table 7: MODBUS register map

	Register (in hex)	Register (in decimal)	Access level	Description	RO/RW	Format
100	100	256	User	Product short tag	RW	CHAR * 16
	108	264	User	Product long tag	RW	CHAR * 32
	118	280	User	Product message (for HART)	RW	CHAR * 32
	128	296	User	Product descriptor (for HART)	RW	CHAR * 16
140	140	320	User	Product electronic serial number	RW	CHAR * 16
	148	328	User	Product fixture serial number	RW	CHAR * 16
	150	336	User	Product transducer1 serial number	RW	CHAR * 16
	158	344	User	Product transducer 2 serial number	RW	CHAR * 16
300	300	768	RO	Main hardware version	RO	CHAR * 8
	304	772	RO	Option hardware version	RO	CHAR * 8
	308	776	RO	Main software version	RO	CHAR * 8

Table 7: MODBUS register map

	Register (in hex)	Register (in decimal)	Access level	Description	RO/RW	Format
500	500	1280	User	Global unit group 1 for actual volumetric	RW	INT32
	502	1282	User	Global unit group 2 for day	RW	INT32
	504	1284	User	Global unit group 3 for dB	RW	INT32
	506	1286	User	Global unit group 4 for density	RW	INT32
	508	1288	User	Global unit group 5 for dimension	RW	INT32
	50A	1290	User	Global unit group 6 for Hz	RW	INT32
	50C	1292	User	Global unit group 7 for viscosity	RW	INT32
	50E	1294	User	Global unit group 8 for mA	RW	INT32
	510	1296	User	Global unit group 9 for mass	RW	INT32
	512	1298	User	Global unit group 10 for milli second	RW	INT32
	514	1300	User	Global unit group 11 for nano second	RW	INT32
	516	1302	User	Global unit group 12 for percent	RW	INT32
	518	1304	User	Global unit group 13 for second	RW	INT32
	51A	1306	User	Global unit group 14 for standard volumetric	RW	INT32
	51C	1308	User	Global unit group 15 for thermo	RW	INT32
	51E	1310	Viewer	Global unit group 16 for totalizer time	RW	INT32
	520	1312	User	Global unit group 17 for totalizer	RW	INT32
	522	1314	User	Global unit group 18 for unitless	RW	INT32
	524	1316	User	Global unit group 19 for micro second	RW	INT32
	526	1318	User	Global unit group 20 for velocity	RW	INT32
	528	1320	User	Global unit group 21 for acceleration	RW	INT32
540	540	1344	Viewer	Batch request command	RW	INT32
	542	1346	User	Inventory request command	RW	INT32
	544	1348	Viewer	System request password	RW	INT32
	546	1350	Viewer	System request command	RW	INT32

Table 7: MODBUS register map

	Register (in hex)	Register (in decimal)	Access level	Description	RO/RW	Format
700	700	1792	RO	System reported error	RO	INT32
	702	1794	RO	System error bitmap	RO	INT32
	704	1796	RO	System startup error bitmap	RO	INT32
	706	1798	RO	System flow error bitmap	RO	INT32
	708	1800	RO	System device error bitmap	RO	INT32
	70A	1802	RO	System warning bitmap	RO	INT32
740	740	1856	RO	System protocol type	RO	INT32
900	900	2304	Viewer	Display language	RW	INT32
	90A	2314	Viewer	Display variable 2 type	RW	INT32
	90C	2316	Viewer	Display totalizer 1 type	RW	INT32
	90E	2318	Viewer	Display totalizer 2 type	RW	INT32
	910	2320	Viewer	Display decimal selection	RW	INT32
940	940	2368	User	Select the velocity	RW	INT32
	942	2370	User	Select the actual volumetric	RW	INT32
	944	2372	User	Select the standardized volumetric	RW	INT32
	946	2374	User	Select mass	RW	INT32
	948	2376	User	Select totalizer	RW	INT32
A00	A00	2560	RO	Display variable 1 value	RO	(IEEE 32 bit)
	A02	2562	RO	Display variable 2 value	RO	(IEEE 32 bit)
	A04	2564	RO	Display totalizer 1 value	RO	(IEEE 32 bit)
	A06	2566	RO	Display totalizer 2 value	RO	(IEEE 32 bit)

Table 7: MODBUS register map

	Register (in hex)	Register (in decimal)	Access level	Description	RO/RW	Format
C00	C00	3072	User	Analog out error handling value	RW	(IEEE 32 bit)
	C02	3074	User	Analog out test value (percent of span)	RW	(IEEE 32 bit)
	C04	3076	User	Analog out zero value	RW	(IEEE 32 bit)
	C06	3078	User	Analog out Span value	RW	(IEEE 32 bit)
	C08	3080	User	Analog out base value	RW	(IEEE 32 bit)
	C0A	3082	User	Analog out full value	RW	(IEEE 32 bit)
C40	C40	3136	User	Digital out 1 pulse value	RW	(IEEE 32 bit)
	C42	3138	User	Digital out 1 frequency base value	RW	(IEEE 32 bit)
	C44	3140	User	Digital out 1 frequency full value	RW	(IEEE 32 bit)
	C46	3142	User	Digital out 1 alarm value	RW	(IEEE 32 bit)
C80	C80	3200	User	Digital out 2 pulse value	RW	(IEEE 32 bit)
	C82	3202	User	Digital out 2 frequency base value	RW	(IEEE 32 bit)
	C84	3204	User	Digital out 2 frequency full value	RW	(IEEE 32 bit)
	C86	3206	User	Digital out 2 alarm value	RW	(IEEE 32 bit)
D00	D00	3328	User	Analog out mode	RW	(IEEE 32 bit)
	D02	3330	User	Analog out type	RW	(IEEE 32 bit)
	D04	3332	User	Digital out 1 mode	RW	(IEEE 32 bit)
	D06	3334	User	Digital out 1 type	RW	(IEEE 32 bit)
	D08	3336	User	Digital out 2 mode	RW	(IEEE 32 bit)
	D0A	3338	User	Digital out 2 type	RW	(IEEE 32 bit)
D20	D20	3360	User	Analog out measurement type	RW	INT32
	D22	3362	User	Analog out error handling	RW	INT32

Table 7: MODBUS register map

	Register (in hex)	Register (in decimal)	Access level	Description	RO/RW	Format
D40	D40	3392	User	Digital out 1 pulse measurement type	RW	INT32
	D42	3394	User	Digital out 1 pulse test value	RW	INT32
	D44	3396	User	Digital out 1 pulse error handling	RW	INT32
	D46	3398	User	Digital out 1 pulse time	RW	INT32
D50	D50	3408	User	Digital out 2 pulse measurement type	RW	INT32
	D52	3410	User	Digital out 2 pulse test value	RW	INT32
	D54	3412	User	Digital out 2 pulse error handling	RW	INT32
	D56	3414	User	Digital out 2 pulse time	RW	INT32
D60	D60	3424	User	Digital out 1 frequency measurement type	RW	INT32
	D62	3426	User	Digital out 1 test frequency value	RW	INT32
	D64	3428	User	Digital out 1 frequency error handling	RW	INT32
	D66	3430	User	Digital out 1 frequency error handling value	RW	INT32
	D68	3432	User	Digital out 1 frequency full frequency	RW	INT32
D70	D70	3440	User	Digital out 2 frequency measurement type	RW	INT32
	D72	3442	User	Digital out 2 test frequency value	RW	INT32
	D74	3444	User	Digital out 2 frequency error handling	RW	INT32
	D76	3446	User	Digital out 2 frequency error handling value	RW	INT32
	D78	3448	User	Digital out 2 frequency full frequency	RW	INT32
D80	D80	3456	User	Digital out 1 alarm measurement type	RW	INT32
	D82	3458	User	Digital out 1 alarm test value	RW	INT32
	D84	3460	User	Digital out 1 alarm state	RW	INT32
	D96	3478	User	Digital out 2 alarm type	RW	INT32

Table 7: MODBUS register map

	Register (in hex)	Register (in decimal)	Access level	Description	RO/RW	Format
D90	D90	3472	User	Digital out 2 alarm measurement type	RW	INT32
	D92	3474	User	Digital out 2 alarm test value	RW	INT32
	D94	3476	User	Digital out 2 alarm state	RW	INT32
	D96	3478	User	Digital out 2 alarm type	RW	INT32
E00	E00	3584	RO	Analog out measurement value	RO	(IEEE 32 bit)
	E02	3586	RO	Digital out 1 pulse measurement value	RO	(IEEE 32 bit)
	E04	3588	RO	Digital out 1 frequency measurement value	RO	(IEEE 32 bit)
	E06	3590	RO	Digital out 1 alarm measurement value	RO	(IEEE 32 bit)
	E08	3592	RO	Digital out 2 pulse measurement value	RO	(IEEE 32 bit)
	E0A	3594	RO	Digital out 2 frequency measurement value	RO	(IEEE 32 bit)
	E0C	3596	RO	Digital out 2 alarm measurement value	RO	(IEEE 32 bit)
1100	1100	4352	Viewer	HART meter address	RW	INT32
	1102	4354	Viewer	HART preamble length	RW	INT32
	1104	4356	Viewer	HART device ID	RW	INT32
	1106	4358	Viewer	HART assembly number	RW	INT32
1140	1140	4416	Viewer	HART dynamic variable index_1	RW	INT32
	1142	4418	Viewer	HART dynamic variable index_2	RW	INT32
	1144	4420	Viewer	HART dynamic variable index_3	RW	INT32
	1146	4422	Viewer	HART dynamic variable index_4	RW	INT32
1300	1300	4864	RO	HART configuration change count	RO	INT32
	1302	4866	RO	HART device status	RO	INT32
	1304	4868	RO	HART device status extended	RO	INT32
	1306	4870	RO	HART master status	RO	INT32
	1308	4872	RO	HART secondary status	RO	INT32
	130A	4874	RO	HART variable status	RO	INT32

Table 7: MODBUS register map

	Register (in hex)	Register (in decimal)	Access level	Description	RO/RW	Format
1500	1500	5376	User	PC MODBUS baud rate	RW	INT32
	1502	5378	User	PC MODBUS parity	RW	INT32
	1504	5380	User	PC MODBUS stop bits	RW	INT32
	1506	5382	User	PC MODBUS meter address	RW	INT32
1540	1540	5440	User	Log control/status	RW	INT32
	1542	5442	User	Log interval	RW	INT32
	1544	5444	User	Logging time	RW	INT32
	1546	5446	User	Number of variables to log	RW	INT32
1580	1580	5504	User	Variable address array	RW	INT32
15C0	15C0	5568	User	Variable unit code array	RW	INT32
1700	1700	5888	RO	PC service baud rate	RO	INT32
	1702	5890	RO	PC service parity	RO	INT32
	1704	5892	RO	PC service stop bits	RO	INT32
	1706	5894	RO	PC service meter address	RO	INT32
1740	1740	5952	RO	Number of records	RO	INT32
2000	2000	8192	User	Pipe inner diameter	RW	(IEEE 32 bit)
	2002	8194	User	Pipe outer diameter	RW	(IEEE 32 bit)
	2004	8196	User	Pipe wall thickness	RW	(IEEE 32 bit)
	2006	8198	User	Pipe sound speed	RW	(IEEE 32 bit)
	2008	8200	User	Lining thickness	RW	(IEEE 32 bit)
	200A	8202	User	Lining sound speed	RW	(IEEE 32 bit)
	200C	8204	User	XDR wedge angle	RW	(IEEE 32 bit)

Table 7: MODBUS register map

	Register (in hex)	Register (in decimal)	Access level	Description	RO/RW	Format
	200E	8206	User	XDR wedge time	RW	(IEEE 32 bit)
	2010	8208	User	Wedge sound speed	RW	(IEEE 32 bit)
	2012	8210	User	Fluid sound speed	RW	(IEEE 32 bit)
	2014	8212	User	Fluid sound speed min	RW	(IEEE 32 bit)
	2016	8214	User	Fluid sound speed max	RW	(IEEE 32 bit)
	2018	8216	User	Fluid static density	RW	(IEEE 32 bit)
	201A	8218	User	Fluid reference density	RW	(IEEE 32 bit)
	201C	8220	User	Fluid temperature	RW	(IEEE 32 bit)
	201E	8222	User	XDR space	RW	(IEEE 32 bit)
	2020	8224	User	Calibration factor	RW	(IEEE 32 bit)
	2022	8226	User	Kinematic viscosity	RW	(IEEE 32 bit)
2040	2040	8256	User	MultiK velocity 1	RW	(IEEE 32 bit)
	2042	8258	User	MultiK velocity 2	RW	(IEEE 32 bit)
	2044	8260	User	MultiK velocity 3	RW	(IEEE 32 bit)
	2046	8262	User	MultiK velocity 4	RW	(IEEE 32 bit)
	2048	8264	User	MultiK velocity 5	RW	(IEEE 32 bit)
	204A	8266	User	MultiK velocity 6	RW	(IEEE 32 bit)
2060	2060	8288	User	MultiK velocity KFactor1	RW	(IEEE 32 bit)
	2062	8290	User	MultiK velocity KFactor2	RW	(IEEE 32 bit)
	2064	8292	User	MultiK velocity KFactor3	RW	(IEEE 32 bit)
	2066	8294	User	MultiK velocity KFactor4	RW	(IEEE 32 bit)
	2068	8296	User	MultiK velocity KFactor5	RW	(IEEE 32 bit)
	206A	8298	User	MultiK velocity KFactor6	RW	(IEEE 32 bit)

Table 7: MODBUS register map

	Register (in hex)	Register (in decimal)	Access level	Description	RO/RW	Format
2080	2080	8320	User	MultiK Reynolds 1	RW	(IEEE 32 bit)
	2082	8322	User	MultiK Reynolds 2	RW	(IEEE 32 bit)
	2084	8324	User	MultiK Reynolds 3	RW	(IEEE 32 bit)
	2086	8326	User	MultiK Reynolds 4	RW	(IEEE 32 bit)
	2088	8328	User	MultiK Reynolds 5	RW	(IEEE 32 bit)
	208A	8330	User	MultiK Reynolds 6	RW	(IEEE 32 bit)
20A0	20A0	8352	User	MultiK Reynolds KFactor1	RW	(IEEE 32 bit)
	20A2	8354	User	MultiK Reynolds KFactor2	RW	(IEEE 32 bit)
	20A4	8356	User	MultiK Reynolds KFactor3	RW	(IEEE 32 bit)
	20A6	8358	User	MultiK Reynolds KFactor4	RW	(IEEE 32 bit)
	20A8	8360	User	MultiK Reynolds KFactor5	RW	(IEEE 32 bit)
	20AA	8362	User	MultiK Reynolds KFactor6	RW	(IEEE 32 bit)
20C0	20C0	8384	User	Correlation peak low limit	RW	(IEEE 32 bit)
	20C2	8386	User	Acceleration limit	RW	(IEEE 32 bit)
	20C4	8388	User	Velocity low limit - used for volumetric low limit calculation	RW	(IEEE 32 bit)
	20C6		User	Velocity high limit - used for volumetric high limit calculation	RW	(IEEE 32 bit)
	20C8	8392	User	Amplitude discriminator min limit	RW	(IEEE 32 bit)
	20CA	8394	User	Amplitude discriminator max limit	RW	(IEEE 32 bit)
	20CC	8396	User	Sound speed plus minus limit	RW	(IEEE 32 bit)
	20CE	8398	User	Signal low limit	RW	(IEEE 32 bit)
20E0	20E0	8416	User	Zero cutoff	RW	(IEEE 32 bit)
	20E2	8418	User	DeltaT offset	RW	(IEEE 32 bit)

Table 7: MODBUS register map

	Register (in hex)	Register (in decimal)	Access level	Description	RO/RW	Format
2100	2100	8448	User	Pipe material	RW	INT32
	2102	8450	User	Lining material	RW	INT32
	2104	8452	User	XDR type	RW	INT32
	2106	8454	User	XDR frequency	RW	INT32
	2108	8456	User	XDR wedge type	RW	INT32
	210A	8458	User	Fluid type	RW	INT32
	210C	8460	User	Lining existence	RW	INT32
	210E	8462	User	Traverse number	RW	INT32
2140	2140	8512	User	Enable Reynolds correction	RW	INT32
	2142	8514	User	Enable active MultiK	RW	INT32
	2144	8516	User	MultiK type	RW	INT32
	2146	8518	User	MultiK pairs	RW	INT32
2180	2180	8576	User	Peak%	RW	INT32
	2182	8578	User	Min peak%	RW	INT32
	2184	8580	User	Max peak%	RW	INT32
	2186	8582	User	Errors allowed	RW	INT32
21C0	21C0	8640	User	Enable active TW	RW	INT32
	21C2	8642	User	Enable tracking windows	RW	INT32
	21C4	8644	User	Response time	RW	INT32
	21C6	8646	User	Sample size	RW	INT32
2200	2200	8704	RO	Velocity	RO	(IEEE 32 bit)
	2202	8706	RO	Volumetric	RO	(IEEE 32 bit)
	2204	8708	RO	Standard volumetric	RO	(IEEE 32 bit)
	2206	8710	RO	Mass flow	RO	(IEEE 32 bit)

Table 7: MODBUS register map

	Register (in hex)	Register (in decimal)	Access level	Description	RO/RW	Format
2240	2240	8768	RO	Batch fwd totals	RO	(IEEE 32 bit)
	2242	8770	RO	Batch rev totals	RO	(IEEE 32 bit)
	2244	8772	RO	Batch net totals	RO	(IEEE 32 bit)
	2246	8774	RO	Batch totals time	RO	(IEEE 32 bit)
	2248	8776	RO	Inventory fwd totals	RO	(IEEE 32 bit)
	224A	8778	RO	Inventory rev totals	RO	(IEEE 32 bit)
	224C	8780	RO	Inventory net totals	RO	(IEEE 32 bit)
	224E	8782	RO	Inventory totals time	RO	(IEEE 32 bit)
2280	2280	8832	RO	Transit time up	RO	(IEEE 32 bit)
	2282	8834	RO	Transit time dn	RO	(IEEE 32 bit)
	2284	8836	RO	DeltaT	RO	(IEEE 32 bit)
	2286	8838	RO	Up signal quality	RO	(IEEE 32 bit)
	2288	8840	RO	Dn signal quality	RO	(IEEE 32 bit)
	228A	8842	RO	Up amp disc	RO	(IEEE 32 bit)
	228C	8844	RO	Dn amp disc	RO	(IEEE 32 bit)
	228E	8846	RO	SNR on UP channel	RO	(IEEE 32 bit)
	2290	8848	RO	SNR on DOWN channel	RO	(IEEE 32 bit)
	2292	8850	RO	Time in buffer on up channel	RO	(IEEE 32 bit)
	2294	8852	RO	Time in buffer on dn channel	RO	(IEEE 32 bit)
	2296	8854	RO	Signal gain up	RO	(IEEE 32 bit)
	2298	8856	RO	Signal gain down	RO	(IEEE 32 bit)

Table 7: MODBUS register map

	Register (in hex)	Register (in decimal)	Access level	Description	RO/RW	Format
22C0	22C0	8896	RO	Sound speed	RO	(IEEE 32 bit)
	22C2	8898	RO	Current Reynolds number	RO	(IEEE 32 bit)
	22C4	8900	RO	Current correction factor	RO	(IEEE 32 bit)
	22C6	8902	RO	Path length P	RO	(IEEE 32 bit)
	22C8	8904	RO	Axial length L	RO	(IEEE 32 bit)
2300	2300	8960	RO	Up +- peak	RO	INT32
	2302	8962	RO	Dn +- peak	RO	INT32
	2304	8964	RO	Dynamic threshold on UP channel	RO	INT32
	2306	8966	RO	Dynamic threshold on DOWN channel	RO	INT32

6.2 HART

6.2.1 Device Identification

The AT600 flow meter supports the HART communication protocol, for which the manufacturer ID is 0x9D (157 Dec) and the device type code is 0x9D73 (127 Dec).

6.2.2 Commands

6.2.2.1 Universal commands

Table 8: Universal commands for HART		
Command	Function	Description
0	Read unique identifier	Returns identity information about the meter including: the device type, revision levels, and device ID.
1	Read primary variable	Returns the primary variable value along with its unit code
2	Read loop current and percent of range	Reads the loop current and its associated percent of range.
3	Read dynamic variables and loop current	Reads the loop current and up to four predefined dynamic variables. The dynamic variables and associated units are defined via commands 51 and 53.
6	Write polling address	Writes the polling address and the loop current mode to the field device.
7	Read loop configuration	Read polling address and the loop current mode.
8	Read dynamic variable upification	Reads the upification associated with the dynamic variable.
9	Read device variables with status	Request the value and status of up to eight device device or dynamic variables.

Table 8: Universal commands for HART		
Command	Function	Description
11	Read unique identifier associated with tag	If the specified tag matches that of the meter, it responds with the command 0 response.
12	Read message	Reads the message contained within the meter.
13	Read tag, descriptor, date	Reads the tag, descriptor, and date contained within the meter.
14	Read primary variable transducer information	Reads the transducer (meter) serial number, limits/minimum span units code, upper transducer limit, lower transducer limit, and minimum span for the primary variable transducer.
15	Read device information	Reads the alarm selection code, transfer function code, range values units code upper range value, primary variable lower range value, damping value, write protect code, and private label distributor code.
16	Read final assembly number	Reads the final assembly number associated with the meter.
17	Write message	Write the message into the meter.

Table 8: Universal commands for HART

Command	Function	Description
18	Write tag, descriptor, date	Write the tag, descriptor, and date code into the meter.
19	Write final assembly number	Write the final assembly number into the meter.
20	Read long tag	Read the 32-byte long tag.
21	Read unique identifier associated with long tag	Read unique identifier associated with long tag
22	Write long tag	Write the 32-byte long tag
38	Reset configuration changed flag	Resets the configuration changed indicator (device status byte bit 6).
48	Read additional device status	Returns meter status information not included in the response code or device status byte.

6.2.2.2 Common commands

Table 9: Common commands

Command	Function	Description
33	Read device variables	Allows a master to request the value of up to four device variables.
50	Read dynamic variable assignments	Reads the device variables assigned to the primary, secondary, tertiary, and quaternary variables.
51	Write dynamic variable assignments	Allows the user to assign device variables to the primary, secondary, tertiary, and quaternary variables
54	Read device variable information	Get device variable information
59	Write number of response preambles	Sets the number of asynchronous preamble bytes to be sent by the meter before the start of a response message.

6.2.2.3 Device specific commands

The AT600 flow meter supports a variety of device-specific commands in which the parameter may be the measurement type. The available measurement types are listed in table 10 below.

Table 10: Available measurement types	
Index	Meaning
1	Velocity
2	Volumetric
3	Standard volumetric
4	Mass flow
5	Batch fwd. totalizer
6	Batch rev. totalizer
7	Batch net totalizer
8	Batch totalizer time
9	Inventory fwd. totalizer
10	Inventory rev. totalizer
11	Inventory net totalizer
12	Inventory totalizer time
13	Sound speed
14	Reynolds Kfactor
15	MultiK Kfactor
16	Transit time up
17	Transit time down

Table 10: Available measurement types	
Index	Meaning
18	DeltaT
19	Signal quality up
20	Signal quality down
21	Amp disc up
22	Amp disc down
23	SNR up
24	SNR down
25	ActiveTW up
26	ActiveTW down
27	Gain up
28	Gain down
29	System error bitmap
30	System report error number
31	Peak up
32	Peak down
33	Peak pct. up
34	Peak pct. down

Command 128 (0x80): Login with password

This command sends a password to the flow meter. If the password is correct, the user may operate the meter until there has been a gap of 10 minutes since the last command.

Table 11:
Request data bytes for login with password

Byte	Format	Description
0 - 3	Unsigned-32	User password

Table 12:
Response data bytes for login with password

Byte	Format	Description
None		

Table 13:
Command-specific response codes for login with password

Code	Class	Description
0	Success	No command-specific errors
1-4		Undefined
5	Error	Too few data bytes received
6	Error	Device-specific command error
7-15		Undefined
16	Error	Access restricted
17-127		Undefined

Command 129 (0x81): Logout and save

This command will save any changes and logout from the flow meter.

Table 14:
Request data bytes for logout and save

Byte	Format	Description
None		

Table 15:
Response data bytes for logout and save

Byte	Format	Description
None		

Table 16:
Command-specific response codes for logout and save

Code	Class	Description
0	Success	No command-specific errors
1-5		Undefined
6	Error	Device-specific command error
7	Error	In write protect mode
8-15		Undefined
16	Error	Access restricted
17-127		Undefined

Command 130 (0x82): Logout without saving

This command will logout the flow meter and not save anything.

Table 17:
Request data bytes for logout without saving

Byte	Format	Description
None		

Table 18:
Response data bytes for logout without saving

Byte	Format	Description
None		

Table 19:
Command-specific response codes for logout without saving

Code	Class	Description
0	Success	No command-specific errors
1-5		Undefined
6	Error	Device-specific command error
7-15		Undefined
16	Error	Access restricted
17-127		Undefined

Command 135 (0x87): Read current user access right

This command will read the current user access right.

Table 20:
Request data bytes for read current user access right

Byte	Format	Description
None		

Table 21:
Response data bytes for read current user access right

Byte	Format	Description
None		

Table 22:
Command-specific response codes for read current user access right

Code	Class	Description
0	Success	No command-specific errors
1-127		Undefined

Command 136 (0x88): Sends new password

This command will send a new password to the flow meter. If the user has the right, the flow meter changes the user password.

Table 23:
Request data bytes for sends new password

Byte	Format	Description
0 - 3	Unsigned-32	User password

Table 24:
Response data bytes for sends new password

Byte	Format	Description
None		

Table 25:
Command-specific response codes for sends new password

Code	Class	Description
0	Success	No command-specific errors
1-4		Undefined
5	Error	Too few data bytes received
6	Error	Device-specific command error
7	Error	In write protect mode
8-15		Undefined
16	Error	Access restricted
17-127		Undefined

Command 144 (0x90): Read unit group

This command will read the unit group in the meter.

Table 26:
Request data bytes for read unit group

Byte	Format	Description
0	Unsigned-8	Group index: 1: Velocity unit; 2: Actual volumetric unit; 3: Standard volumetric unit; 4: Mass unit; 5: Totalizer unit; 6: Density unit; 7: Pipe dimension; 8: Thermal; 9: Acceleration;

Table 27:
Response data bytes for read unit group

Byte	Format	Description
0	Unsigned-8	Group index: 1: Velocity unit; 2: Actual volumetric unit; 3: Standard volumetric unit; 4: Mass unit; 5: Totalizer unit; 6: Density unit; 7: Pipe dimension; 8: Thermal; 9: Acceleration;
1	Enum	Unit code

Table 28:
Command-specific response codes for read unit group

Code	Class	Description
0	Success	No command-specific errors
1		Undefined
2	Error	Invalid selection
3-4		Undefined
5	Error	Too few data bytes received
6	Error	Device-specific command error
7-127		Undefined

Command 145 (0x91): Read density value

This command will read density value in meter.

Table 29:
Request data bytes for read density value

Byte	Format	Description
0	Unsigned-8	Density type: 1: Actual density; 2: Reference density;

Table 30:
Response data bytes for read density value

Byte	Format	Description
0	Unsigned-8	Density type: 1: Actual density; 2: Reference density;
1	Unsigned-8	Density unit code
2-5	Float	Density value

Table 31:
Command-specific response codes for read density value

Code	Class	Description
0	Success	No command-specific errors
1		Undefined
2	Error	Invalid selection
3-4		Undefined
5	Error	Too few data bytes received
6	Error	Device-specific command error
7-127		Undefined

Command 146 (0x92): Read backlight setting

This command is to read the backlight setting.

Table 32:
Request data bytes for read backlight setting

Byte	Format	Description
None		

Table 33:
Response data bytes for read backlight setting

Byte	Format	Description
0	Unsigned-8	Backlight control switch (0:off/ 1:on)
1-4	Unsigned-32	Display backlight timeout, unit is second.

Table 34:
Command-specific response codes for read
backlight setting

Code	Class	Description
0	Success	No command-specific errors
1-5		Undefined
6	Error	Device-specific command error
7-127		Undefined

Command 152 (0x98): Write unit group

This command will write unit group in meter.

Table 35:
Request data bytes for write unit group

Byte	Format	Description
0	Unsigned-8	Group index: 1: Velocity unit; 2: Actual volumetric unit; 3: Standard volumetric unit; 4: Mass unit; 5: Totalizer unit; 6: Density unit; 7: Pipe dimension; 8: Thermal; 9: Acceleration;
1	Enum	Unit code

Table 36:
Response data bytes for write unit group

Byte	Format	Description
0	Unsigned-8	Group index: 1: Velocity unit; 2: Actual volumetric unit; 3: Standard volumetric unit; 4: Mass unit; 5: Totalizer unit; 6: Density unit; 7: Pipe dimension; 8: Thermal; 9: Acceleration;
1	Enum	Unit code

Table 37:
Command-specific response codes for write unit group

Code	Class	Description
0	Success	No command-specific errors
1		Undefined
2	Error	Invalid selection
3-4		Undefined
5	Error	Too few data bytes received
6	Error	Device-specific command error
7	Error	In write protect mode
8-15		Undefined
16	Error	Access restricted
17-127		Undefined

Command 153 (0x99): Write density value

This command will write density value in meter.

Table 38:
Request data bytes for write density value

Byte	Format	Description
0	Unsigned-8	Density type: 1: Actual density; 2: Reference density;
1	Unsigned-8	Density unit code
2-5	Float	Density value

Table 39:
Response data bytes for write density value

Byte	Format	Description
0	Unsigned-8	Density type: 1: Actual density; 2: Reference density;
1	Unsigned-8	Density unit code
2-5	Float	Density value

Table 40:
Command-specific response codes for write density value

Code	Class	Description
0	Success	No command-specific errors
1		Undefined
2	Error	Invalid selection
3-4		Undefined
5	Error	Too few data bytes received
6	Error	Device-specific command error
7	Error	In write protect mode
8-15		Undefined
16	Error	Access restricted
17-127		Undefined

Command 154 (0x9A): Write display backlight

This command is to set the back light.

Table 41:
Request data bytes for write display backlight

Byte	Format	Description
0	Unsigned-8	Backlight control switch (0:off/ 1:on)
1-4	Unsigned-32	Display backlight timeout, unit is second.

Table 42:
Response data bytes for write display backlight

Byte	Format	Description
0	Unsigned-8	Backlight control switch (0:off/ 1:on)
1-4	Unsigned-32	Display backlight timeout, unit is second.

Table 43:
Command-specific response codes for write display backlight

Code	Class	Description
0	Success	No command-specific errors
1-4		Undefined
5	Error	Too few data bytes received
6	Error	Device-specific command error
7	Error	In write protect mode
8-15		Undefined
16	Error	Access restricted
17-127		Undefined

Command 160 (0xA0): Read analog measurement range values

This command is to read the analog measurement range.

Table 44:
Request data bytes for read analog measurement range values

Byte	Format	Description
None		

Table 45:
Response data bytes for read analog measurement range value

Byte	Format	Description
0	Unsigned-8	Upper and lower range values unit code
1-4	Float	Upper range value
5-8	Float	Lower range value

Table 46:
Command-specific response codes for read analog measurement range value

Code	Class	Description
0	Success	No command-specific errors
1-5		Undefined
6	Error	Device-specific command error
7-127		Undefined

Command 161 (0xA1): Read loop current error handling

This command is to read the loop current output error handling.

Table 47:
Request data bytes for read loop current error handling

Byte	Format	Description
None		

Table 48:
Response data bytes for read loop current error handling

Byte	Format	Description
0	Unsigned-8	Analog output error handling: 0: Low; 1: High; 2: Hold; 3: Other value;
1-4	Float	Error value, unit is mA

Table 49:
Command-specific response codes for read loop current error handling

Code	Class	Description
0	Success	No command-specific errors
1-5		Undefined
6	Error	Device-specific command error
7-127		Undefined

Command 168 (0xA8): Enter/exit fixed loop current

Enter or exit the fixed mode of loop current.

Table 50:
Request data bytes for enter/exit fixed loop current

Byte	Format	Description
0	Unsigned-8	Fixed current level: 0: Exit fixed loop current; 1: fixed 4 mA; 2: fixed 20mA; 3: fixed percentage of scale

Table 51:
Response data bytes for enter/exit fixed loop current

Byte	Format	Description
0	Unsigned-8	Fixed current level: 0: Exit fixed loop current; 1: fixed 4 mA; 2: fixed 20mA; 3: fixed percentage of scale

Table 52:
Command-specific response code for enter/exit fixed loop currents

Code	Class	Description
0	Success	No command-specific errors
1-4		Undefined
5	Error	Too few data bytes received
6	Error	Device-specific command error
7	Error	In write protect mode
8-10		Undefined
11	Error	Loop current not active
12-15		Undefined
16	Error	Access restricted
17-31		Undefined
32	Error	Busy
33-127		Undefined

Command 169 (0xA9): Set loop current zero

This command is to trim the zero or lower endpoint value of the loop current to its minimum.

Table 53:
Request data bytes for set loop current zero

Byte	Format	Description
0-3	Float	Externally measured loop current level, units of milliamperes

Table 54:
Response data bytes for set loop current zero

Byte	Format	Description
0-3	Float	Externally measured loop current level, units of milliamperes

Table 55:
Command-specific response codes for set loop current zero

Code	Class	Description
0	Success	No command-specific errors
1-2		Undefined
3	Error	Passed parameter too large
4	Error	Passed parameter too small
5	Error	Too few data bytes received
6	Error	Device-specific command error
7	Error	In write protect mode
8		Undefined
9	Error	Incorrect loop current mode or value
10 - 15		Undefined
16	Error	Access restricted
17-31		Undefined
32	Error	Busy
33 - 127		Undefined

Command 170 (0xAA): Set loop current gain

This command is to trim the gain or upper endpoint value of the loop current to its maximum.

Table 56:
Request data bytes for set loop current gain

Byte	Format	Description
0-3	Float	Externally measured loop current level, units of milliamperes

Table 57:
Response data bytes for set loop current gain

Byte	Format	Description
0-3	Float	Externally measured loop current level, units of milliamperes

Table 58:
Command-specific response codes for set loop current gain

Code	Class	Description
0	Success	No command-specific errors
0	Success	No command-specific errors
1-2		Undefined
3	Error	Passed parameter too large
4	Error	Passed parameter too small
5	Error	Too few data bytes received
6	Error	Device-specific command error
7	Error	In write protect mode
8		Undefined
9	Error	Incorrect loop current mode or value
10 - 15		Undefined
16	Error	Access restricted
17 - 31		Undefined
32	Error	Busy
33 - 127		Undefined

Command 171 (0xAB): Set loop current percentage

This command is to set the output percentage of loop current.

Table 59:
Request data bytes for set loop current percentage

Byte	Format	Description
0 - 3	Float	Loop current percentage, units of percent.

Table 60:
Response data bytes for set loop current percentage

Byte	Format	Description
0 - 3	Float	Loop current percentage, units of percent.

Table 61:
Command-specific response codes for set loop current percentage

Code	Class	Description
0	Success	No command-specific errors
1-2		Undefined
3	Error	Passed parameter too large
4	Error	Passed parameter too small
5	Error	Too few data bytes received
6	Error	Device-specific command error
7	Error	In write protect mode
8		Undefined
9	Error	Incorrect loop current mode or value
10 - 15		Undefined
16	Error	Access restricted
17-31		Undefined
32	Error	Busy
33 - 127		Undefined

Command 172 (0xAC): Set analog measurement range values

This command is to set the analog measurement range.

Table 62:
Request data bytes for set analog measurement range values

Byte	Format	Description
0	Unsigned-8	Upper and lower range values unit code
1 - 4	Float	Upper range value
5 - 8	Float	Lower range value

Table 63:
Response data bytes for set analog measurement range values

Byte	Format	Description
0	Unsigned-8	Upper and lower range values unit code
1 - 4	Float	Upper range value
5 - 8	Float	Lower range value

Table 64:
Command-specific response codes for set analog measurement range values

Code	Class	Description
0	Success	No command-specific errors
1 - 4		Undefined
5	Error	Too few data bytes received
6	Error	Device-specific command error
7	Error	In write protect mode
8	Warning	Set to nearest possible value (upper or lower range pushed)
9	Error	Lower range value too high
10	Error	Lower range value too low
11	Error	Upper range value too high
12	Error	Upper range value too low
13 - 15		Undefined
16	Error	Access restricted
17		Undefined
18	Error	Invalid units code
19 - 31		Undefined
32	Error	Busy
33 - 127		Undefined

Command 173 (0xAD): Set loop current error handling

This command will set the loop current output error handling.

Table 65:
Request data bytes for set loop current error handling

Byte	Format	Description
0	Unsigned-8	Analog output error handling: 0: Low; 1: High; 2: Hold; 3: Other value;
1 - 4	Float	Error value, unit is mA

Table 66:
Response data bytes for set loop current error handling

Byte	Format	Description
0	Unsigned-8	Analog output error handling: 0: Low; 1: High; 2: Hold; 3: Other value;
1 - 4	Float	Error value, unit is mA

Table 67:
Command-specific response codes for set loop current error handling

Code	Class	Description
0	Success	No command-specific errors
1-4		Undefined
5	Error	Too few data bytes received
6	Error	Device-specific command error
7	Error	In write protect mode
8-15		Undefined
16	Error	Access restricted
17-127		Undefined

Command 176 (0xB0): Read digital configuration

This command is to read the digital output configuration.

Table 68:
Request data bytes

Byte	Format	Description
None	Unsigned-8	Channel number (1/2)

Table 69:
Response data bytes

Byte	Format	Description
0	Unsigned-8	Channel number
1	Unsigned-8	Digital output type: 0: Off; 1: Pulse; 2: Frequency; 3: Alarm;

Table 70:
Command-specific response codes

Code	Class	Description
0	Success	No command-specific errors
1		Undefined
2	Error	Invalid selection
3-4		Undefined
5	Error	Too few data bytes received
6	Error	Device-specific command error
7-127		Undefined

Command 177 (0xB1): Read pulse configuration

This command is to read the pulse configuration.

Table 71:
Request data bytes for read pulse configuration

Byte	Format	Description
0	Unsigned-8	Channel number (1/2)

Table 72:
Response data bytes for read pulse configuration

Byte	Format	Description
0	Unsigned-8	Channel number
1	Unsigned-8	Measurement type: 5: Forward batch total; 6: Reverse batch total; 7: Net batch total;
2	Unsigned-8	Pulse value unit
3 - 6	Float	Pulse value
7 - 10	Unsigned-32	Pulse time, unit is MS
11	Unsigned-8	Pulse error handling: 2: Hold good value; 4: Stop;

Table 73:
Command-specific response codes for read pulse configuration

Code	Class	Description
0	Success	No command-specific errors
1		Undefined
2	Error	Invalid selection
3-4		Undefined
5	Error	Too few data bytes received
6	Error	Device-specific command error
7-127		Undefined

Command 178 (0xB2): Read frequency configuration

This command is to read the frequency configuration.

Table 74:
Request data bytes for read frequency configuration

Byte	Format	Description
0	Unsigned-8	Channel number (1/2)

Table 75:
Response data bytes for read frequency configuration

Byte	Format	Description
0	Unsigned-8	Channel number
1	Unsigned-8	Measurement type
2	Unsigned-8	Frequency value unit
3 - 6	Float	Frequency base value
7 - 10	Float	Frequency full value
11 - 14	Unsigned-32	Full frequency, unit is Hz
15	Unsigned-8	Frequency error handling: 0: Low; 1: High; 2: Hold; 3: Value
16 - 19	Unsigned-32	Error handling value, unit is Hz

Table 76:
Command-specific response codes for read frequency configuration

Code	Class	Description
0	Success	No command-specific errors
1		Undefined
2	Error	Invalid selection
3-4		Undefined
5	Error	Too few data bytes received
6	Error	Device-specific command error
7-127		Undefined

Command 179 (0xB3): Read alarm configuration

This command is to read the alarm configuration.

Table 77:
Request data bytes for read alarm configuration

Byte	Format	Description
0	Unsigned-8	Channel number (1/2)

Table 78:
Response data bytes for read alarm configuration

Byte	Format	Description
0	Unsigned-8	Channel number
1	Unsigned-8	Measurement type
2	Unsigned-8	Alarm value unit
3 - 6	Float	Alarm value
7	Unsigned-8	Alarm type: 0: Low; 1: High; 2: Fault
8	Unsigned-8	Alarm state: 0: Normally; 1: Failsafe;

Table 79:
Command-specific response codes for read alarm configuration

Code	Class	Description
0	Success	No command-specific errors
1		Undefined
2	Error	Invalid selection
3-4		Undefined
5	Error	Too few data bytes received
6	Error	Device-specific command error
7-127		Undefined

Command 184 (0xB8): Write digital configuration

This command is to write the digital output configuration.

Table 80:
Request data bytes for write digital configuration

Byte	Format	Description
0	Unsigned-8	Channel number(1/2)
1	Unsigned-8	Digital output type: 0: Off; 1: Pulse; 2: Frequency; 3: Alarm;

Table 81:
Response data bytes for write digital configuration

Byte	Format	Description
0	Unsigned-8	Channel number(1/2)
1	Unsigned-8	Digital output type: 0: Off; 1: Pulse; 2: Frequency; 3: Alarm;

Table 82:
Command-specific response codes for write digital configuration

Code	Class	Description
0	Success	No command-specific errors
1		Undefined
2	Error	Invalid selection
3-4		Undefined
5	Error	Too few data bytes received
6	Error	Device-specific command error
7	Error	In write protect mode
8-15		Undefined
16	Error	Access restricted
8-127		Undefined

Command 185 (0xB9): Write pulse configuration

This command is to write the pulse configuration.

Table 83:
Request data bytes for write pulse configuration

Byte	Format	Description
0	Unsigned-8	Channel number (1/2)
1	Unsigned-8	Measurement type: 5: Forward batch total; 6: Reverse batch total; 7: Net batch total;
2	Unsigned-8	Pulse value unit
3 - 6	Float	Pulse value
7 - 10	Unsigned-32	Pulse time, unit is ms
11	Unsigned-8	Pulse error handling: 2: Hold good value; 4: Stop;

Table 84:
Response data bytes for write pulse configuration

Byte	Format	Description
0	Unsigned-8	Channel number(1/2)
1	Unsigned-8	Measurement type: 5: Forward batch total; 6: Reverse batch total; 7: Net batch total;
2	Unsigned-8	Pulse value unit
3 - 6	Float	Pulse value
7 - 10	Float	Pulse time, unit is ms
11	Unsigned-8	Pulse error handling: 0: Hold good value; 1: Stop;

Table 85:
Command-specific response codes for write pulse configuration

Code	Class	Description
0	Success	No command-specific errors
1		Undefined
2	Error	Invalid selection
3-4		Undefined
5	Error	Too few data bytes received
6	Error	Device-specific command error
7	Error	In write protect mode
8-15		Undefined
16	Error	Access restricted
8-127		Undefined

Command 186 (0xBA): Write frequency configuration

This command is to write the frequency configuration.

Table 86:
Request data bytes for write frequency configuration

Byte	Format	Description
0	Unsigned-8	Channel number (1/2)
1	Unsigned-8	Measurement type
2	Unsigned-8	Frequency value unit
3 - 6	Float	Frequency base value
7 - 10	Float	Frequency full value
11 - 14	Unsigned-32	Full frequency, unit is Hz
15	Unsigned-8	Frequency error handling: 0: Low; 1: High; 2: Hold; 3: Value
16 - 19	Unsigned-32	Error handling value, unit is Hz

Table 87:
Response data bytes for write frequency configuration

Byte	Format	Description
0	Unsigned-8	Channel number(1/2)
1	Unsigned-8	Measurement type
2	Unsigned-8	Frequency value unit
3 - 6	Float	Frequency base value
7 - 10	Float	Frequency full value
11 - 14	Float	Full frequency, unit is Hz
15	Unsigned-8	Frequency error handling: 0: Low; 1: High; 2: Hold; 3: Value
16 - 19	Unsigned-32	Error handling value, unit is Hz

Table 88:
Command-specific response codes for write frequency configuration

Code	Class	Description
0	Success	No command-specific errors
1		Undefined
2	Error	Invalid selection
3-4		Undefined
5	Error	Too few data bytes received
6	Error	Device-specific command error
7	Error	In write protect mode
8-15		Undefined
16	Error	Access restricted
8-127		Undefined

Command 187 (0xBB): Write alarm configuration

This command is to write the alarm configuration.

Table 89:
Request data bytes for write alarm configuration

Byte	Format	Description
0	Unsigned-8	Channel number(1/2)
1	Unsigned-8	Measurement type
2	Unsigned-8	Alarm value unit
3 - 6	Float	Alarm value
7	Unsigned-8	Alarm type: 0: Low; 1: High; 2: Fault
8	Unsigned-8	Alarm state: 0: Normally; 1: Failsafe;

Table 90:
Response data bytes for write alarm configurations

Byte	Format	Description
0	Unsigned-8	Channel number(1/2)
1	Unsigned-8	Measurement type
2	Unsigned-8	Alarm value unit
3 - 6	Float	Alarm value
7	Unsigned-8	Alarm type: 0: Low; 1: High; 2: Fault
8	Unsigned-8	Alarm state: 0: Normally; 1: Failsafe;

Table 91:
Command-specific response codes for write alarm configuration

Code	Class	Description
0	Success	No command-specific errors
1		Undefined
2	Error	Invalid selection
3-4		Undefined
5	Error	Too few data bytes received
6	Error	Device-specific command error
7	Error	In write protect mode
8-15		Undefined
16	Error	Access restricted
8-127		Undefined

Command 191 (0xBF): Test digital output

This command is to test the digital output

Table 92:
Request data bytes for test digital output

Byte	Format	Description
0	Unsigned-8	Channel number(1/2)
1	Unsigned-8	Test DO type Test stop Pulse Frequency Alarm
2 - 5	Unsigned-32	Test value

Table 93:
Response data bytes for test digital output

Byte	Format	Description
0	Unsigned-8	Channel number(1/2)
1	Unsigned-8	Test DO type Test stop Pulse Frequency Alarm;
2 - 5	Unsigned-32	Test value

Table 94:
Command-specific response codes for test digital output

Code	Class	Description
0	Success	No command-specific errors
1		Undefined
2	Error	Invalid selection
3-4		Undefined
5	Error	Too few data bytes received
6	Error	Device-specific command error
7	Error	In write protect mode
8-15		Undefined
16	Error	Access restricted
8-127		Undefined

Command 192 (0xC0): Read pipe size

This command is to read pipe size.

Table 95:
Request data bytes for read pipe size

Byte	Format	Description
None		

Table 96:
Response data bytes for read pipe size

Byte	Format	Description
0	Unsigned-8	Pipe size unit
1 - 4	Float	Pipe OD value
5 - 8	Float	Pipe ID value
9 - 12	Float	Pipe WT value

Table 97:
Command-specific response codes for read pipe size

Code	Class	Description
0	Success	No command-specific errors
1-5		Undefined
6	Error	Device-specific command error
7-127		Undefined

Command 193 (0xC1): Read pipe material

This command is to read pipe material.

Table 98:
Request data bytes for read pipe material

Byte	Format	Description
None		

Table 99:
Response data bytes for read pipe material

Byte	Format	Description
0 - 3	Unsigned-32	Pipe material
4 - 7	Float	Pipe sound speed

Table 100:
Command-specific response codes for read pipe material

Code	Class	Description
0	Success	No command-specific errors
1-5		Undefined
6	Error	Device-specific command error
7-127		Undefined

Command 194 (0xC2): Read pipe lining attribute

This command is to read pipe lining attribute.

Table 101:
Request data bytes for read pipe lining attribute

Byte	Format	Description
None		

Table 102:
Response data bytes for read pipe lining attribute

Byte	Format	Description
0	Unsigned-8	Lining existing
1 – 4	Float	Lining thickness
5 – 8	Unsigned-32	Lining material
9 – 12	Float	Lining sound speed

Table 103:
Command-specific response codes for read pipe lining attribute

Code	Class	Description
0	Success	No command-specific errors
1-5		Undefined
6	Error	Device-specific command error
7-127		Undefined

Command 195 (0xC3): Read sensor meter setup

This command is to read the sensor meter setup.

Table 104:
Request data bytes for read sensor meter setup

Byte	Format	Description
None		

Table 105:
Response data bytes for read sensor meter setup

Byte	Format	Description
0-3	Float	Zero cutoff

Table 106:
Command-specific response codes for read sensor meter setup

Code	Class	Description
0	Success	No command-specific errors
1-5		Undefined
6	Error	Device-specific command error
7-127		Undefined

Command 196 (0xC4): Read transducer information

This command is to read transducer information.

Table 107:
Request data bytes for read transducer information

Byte	Format	Description
None		

Table 108: Response data bytes for read transducer information

Byte	Format	Description
0-3	Unsigned-32	Transducer type: 0: Other; 10: CPT-0.5 11: CPT-2.0 12: CPT-0.5-MT C-PB-05-M 13: CPT-1.0-MT C-PB-10-M 14: CPT-2.0-MT C-PB-20-M 15: CPT-0.5-HT 16: CPT-1.0-HT 17: CPT-2.0-HT 18: CPS-0.5 19: CPSM-2.0 20: CTS-1.0 21: CTS-1.0-HT 22: CTS-2.0 23: C-LP-40-HM 24: C-LP-40-NM 25: CPB-0.5-HT 26: CPB-2.0-MT 27: CPB-0.5-MT 28: CPB-2.0 29: CPB-0.5 30: CPS-1.0 CPT-1. 31: CWL-2 32: CPS-1.0 33: CPW (WT-1P-1.0 on AB82) 34: CPW (WT-1P-0.5 on NDT plastic) 35: CPW (WT-1P-1.0 on NDT plastic) 36: CPB-1.0-HT

Table 108: Response data bytes for read transducer information

Byte	Format	Description
		37: CPB-2.0-HT 38: CPB-1.0 39: CPB-1.0-MT 301: C-RL-0.5 302: C-RL-1 304: C-RL-0.5
		305: C-RL-1 307: C-RL-0.5 308: C-RL-1 310: C-RV-0.5 311: C-RV-1 313: C-RW-0.5 314: C-RW-1 401: C-RS 0.5M 402: C-RS 1M 403: C-RS 2M 407: UTXDR-2 408: UTXDR-5 601: CAT0.5M 602: CAT1M 603: CAT2M
4 - 7	Unsigned-32	Transducer frequency
8 - 11	Unsigned-32	Transducer wedge type
12 - 15	Float	Transducer wedge angle
16 - 19	Float	Transducer wedge SOS
20 - 23	Float	Transducer Tw

Table 109:
Command-specific response codes for read transducer information

Code	Class	Description
0	Success	No command-specific errors
1-5		Undefined
6	Error	Device-specific command error
7-127		Undefined

Command 197 (0xC5): Read transducer traverses and spacing

This command is to read transducer traverses and spacing.

Table 110:
Request data bytes for read transducer traverses and spacing

Byte	Format	Description
None		

Table 111:
Response data bytes for read transducer traverses and spacing

Byte	Format	Description
0	Unsigned-8	Transducer traverse
1 - 4	Float	Transducer spacing

Table 112:
Command-specific response codes for read transducer traverses and spacing

Code	Class	Description
0	Success	No command-specific errors
1-5		Undefined
6	Error	Device-specific command error
7-127		Undefined

Command 198 (0xC6): Read fluid information

This command is to read fluid information.

Table 113:
Request data bytes for read fluid information

Byte	Format	Description
None		

Table 114:
Response data bytes for read fluid information

Byte	Format	Description
0 - 3	Unsigned-32	Fluid type: 0: Other 1: Water
4 - 7	Float	Fluid SOS
8 - 11	Float	Fluid minimum SOS
12 - 15	Float	Fluid maximum SOS
16 - 19	Float	Fluid temperature

Table 115:
Command-specific response codes for read fluid information

Code	Class	Description
0	Success	No command-specific errors
1-5		Undefined
6	Error	Device-specific command error
7-127		Undefined

Command 200 (0xC8): Write pipe size

This command is to write pipe size.

Table 116:
Request data bytes for write pipe size

Byte	Format	Description
0	Unsigned-8	Pipe size unit
1 - 4	Float	Pipe OD value
5 - 8	Float	Pipe ID value
9 - 12	Float	Pipe WT value

Table 117:
Response data bytes for write pipe size

Byte	Format	Description
0	Unsigned-8	Pipe size unit
1 - 4	Float	Pipe OD value
5 - 8	Float	Pipe ID value
9 - 12	Float	Pipe WT value

Table 118:
Command-specific response codes for write pipe size

Code	Class	Description
0	Success	No command-specific errors
1-4		Undefined
5	Error	Too few data bytes received
6	Error	Device-specific command error
7	Error	In write protect mode
8-15		Undefined
16	Error	Access restricted
17		Undefined
18	Error	Wrong unit code
19-127		Undefined

Command 201 (0xC9): Write pipe material

This command is to write pipe material.

Table 119:
Request data bytes for write pipe material

Byte	Format	Description
0 - 3	Unsigned-32	Pipe material
4 - 7	Float	Pipe sound speed

Table 120:
Response data bytes for write pipe material

Byte	Format	Description
0 - 3	Unsigned-32	Pipe material
4 - 7	Float	Pipe sound speed

Table 121:
Command-specific response codes for write pipe material

Code	Class	Description
0	Success	No command-specific errors
1-4		Undefined
5	Error	Too few data bytes received
6	Error	Device-specific command error
7	Error	In write protect mode
8-15		Undefined
16	Error	Access restricted
17-127		Undefined

Command 202 (0xCA): Write pipe lining attribute

This command is to write pipe lining attribute.

Table 122:
Request data bytes for write pipe lining attribute

Byte	Format	Description
0	Unsigned-8	Lining existing
1 – 4	Float	Lining thickness
5 – 8	Unsigned-32	Lining material
9 – 12	Float	Lining sound speed

Table 123:
Response data bytes for write pipe lining attribute

Byte	Format	Description
0	Unsigned-8	Lining existing
1 – 4	Float	Lining thickness
5 – 8	Unsigned-32	Lining material
9 – 12	Float	Lining sound speed

Table 124:
Command-specific response codes for write pipe lining attribute

Code	Class	Description
0	Success	No command-specific errors
1-4		Undefined
5	Error	Too few data bytes received
6	Error	Device-specific command error
7	Error	In write protect mode
8-15		Undefined
16	Error	Access restricted
17-127		Undefined

Command 203 (0xCB): Write sensor meter setup

This command is to write sensor meter setup.

Table 125:
Request data bytes for write sensor meter setup

Byte	Format	Description
0 – 3	Float	Zero cutoff

Table 126: Response data bytes

Byte	Format	Description
0 – 3	Float	Zero cutoff

Table 127:
Command-specific response codes for write sensor meter setup

Code	Class	Description
0	Success	No command-specific errors
1-4		Undefined
5	Error	Too few data bytes received
6	Error	Device-specific command error
7	Error	In write protect mode
8-15		Undefined
16	Error	Access restricted
17-127		Undefined

Command 204 (0xCC): Write transducer information

This command is to write transducer information.

Table 128:
Request data bytes for write transducer information

Byte	Format	Description
0 - 3	Unsigned-32	Transducer type: 0: Other; 10: CPT-0.5 11: CPT-2.0 12: CPT-0.5-MT C-PB-05-M 13: CPT-1.0-MT C-PB-10-M 14: CPT-2.0-MT C-PB-20-M 15: CPT-0.5-HT 16: CPT-1.0-HT 17: CPT-2.0-HT 18: CPS-0.5 19: CPSM-2.0 20: CTS-1.0 21: CTS-1.0-HT 22: CTS-2.0 23: C-LP-40-HM 24: C-LP-40-NM 25: CPB-0.5-HT 26: CPB-2.0-MT 27: CPB-0.5-MT 28: CPB-2.0 29: CPB-0.5 30: CPS-1.0 CPT-1.0 31: CWL-2 32: CPS-1.0 33: CPW (WT-1P-1.0 on AB82) 34: CPW (WT-1P-0.5 on NDT plastic) 35: CPW (WT-1P-1.0 on NDT plastic) 36: CPB-1.0-HT 37: CPB-2.0-HT 38: CPB-1.0 39: CPB-1.0-MT 301: C-RL-0.5 302: C-RL-1 304: C-RL-0.5 305: C-RL-1 307: C-RL-0.5
0 - 3	Unsigned-32	Transducer type: 0: Other;
4 - 7	Unsigned-32	Transducer frequency

Byte	Format	Description
8 - 11	Unsigned-32	Transducer wedge type
12 - 15	Unsigned-32	Transducer wedge angle
16 - 19	Unsigned-32	Transducer wedge SOS
20 - 23	Unsigned-32	Transducer Tw

Table 129:
Response data bytes for write transducer information

Byte	Format	Description
0 - 3	Unsigned-32	Transducer type: 0: Other;
4 - 7	Unsigned-32	Transducer frequency
8 - 11	Unsigned-32	Transducer wedge type
12 - 15	Unsigned-32	Transducer wedge angle
16 - 19	Unsigned-32	Transducer wedge SOS
20 - 23	Unsigned-32	Transducer Tw

Table 130:
Command-specific response codes for write transducer information

Code	Class	Description
0	Success	No command-specific errors
1-4		Undefined
5	Error	Too few data bytes received
6	Error	Device-specific command error
7	Error	In write protect mode
8-15		Undefined
16	Error	Access restricted
17-127		Undefined

Command 205 (0xCD): Write transducer traverses and spacing

This command is to write transducer traverses and spacing.

Table 131:
Request data bytes for write transducer traverses and spacing

Byte	Format	Description
0	Unsigned-8	Transducer traverse
1 - 4	Float	Transducer spacing

Table 132: Response data bytes for write transducer traverses and spacing

Byte	Format	Description
0	Unsigned-8	Transducer traverse
1 - 4	Unsigned-32	Transducer spacing

Table 133:
Command-specific response codes for write transducer traverses and spacing

Code	Class	Description
0	Success	No command-specific errors
1-4		Undefined
5	Error	Too few data bytes received
6	Error	Device-specific command error
7	Error	In write protect mode
8-15		Undefined
16	Error	Access restricted
17-127		Undefined

Command 206 (0xCE): Write fluid information

This command is to write fluid information.

Table 134:
Request data bytes for write fluid information

Byte	Format	Description
0 - 3	Unsigned-32	Fluid type: 0: Other 1. Water
4 - 7	Float	Fluid SOS
8 - 11	Float	Fluid minimum SOS
12 - 15	Float	Fluid maximum SOS
16 - 19	Float	Fluid temperature

Table 135:
Response data bytes for write fluid information

Byte	Format	Description
0 - 3	Unsigned-32	Fluid type: 0: Other 1. Water
4 - 7	Float	Fluid SOS
8 - 11	Float	Fluid minimum SOS
12 - 15	Float	Fluid maximum SOS
16 - 19	Float	Fluid temperature

Table 136:
Command-specific response codes

Code	Class	Description
0	Success	No command-specific errors
1		Undefined
2	Error	Invalid selection
3-4		Undefined
5	Error	Too few data bytes received
6	Error	Device-specific command error
7	Error	In write protect mode
8-15		Undefined
16	Error	Access restricted
17-127		Undefined

Command 208 (0xD0): Read calibration configuration

This command is to read calibration configuration.

Table 137:
Request data bytes for read calibration configuration

Byte	Format	Description
None		

Table 138:
Response data bytes for read calibration configuration

Byte	Format	Description
0	Unsigned-8	Reynolds correction
1	Unsigned-8	Active MultiK Enable
2	Unsigned-8	KFactor type: 0: Velocity, 1: Reynolds
3 – 6	Float	Static KFactor
7	Unsigned-8	KFactor points
8 – 11	Float	Kinematic viscosity

Table 139:
Command-specific response codes for read calibration configuration

Code	Class	Description
0	Success	No command-specific errors
1-5		Undefined
6	Error	Device-specific command error
7-127		Undefined

Command 209 (0xD1): Read velocity KFactor table

This command is to read the velocity KFactor table.

Table 140:
Request data bytes for read velocity KFactor table

Byte	Format	Description
0	Unsigned-8	Velocity KFactor index (1 – 6)

Table 141:
Response data bytes for read velocity KFactor table

Byte	Format	Description
0	Unsigned-8	Velocity KFactor index (1 – 6)
1	Unsigned-8	Velocity unit
2 – 5	Float	Velocity value
6 – 9	Float	Velocity KV value;

Table 142:
Command-specific response codes for read velocity KFactor table

Code	Class	Description
0	Success	No command-specific errors
1		Undefined
2	Error	Invalid selection
3-4		Undefined
5	Error	Too few data bytes received
6	Error	Device-specific command error
7-127		Undefined

Command 210 (0xD2): read Reynolds KFactor table

This command is to read Reynolds KFactor table.

Table 143:
Request data bytes for read Reynolds KFactor table

Byte	Format	Description
0	Unsigned-8	Reynolds KFactor index (1 - 6)

Table 144:
Response data bytes for read Reynolds KFactor table

Byte	Format	Description
0	Unsigned-8	Reynolds KFactor index (1 - 6)
1 - 4	Float	Reynolds value
5 - 8	Float	Reynolds KV value;

Table 145:
Command-specific response codes for read Reynolds KFactor table

Code	Class	Description
0	Success	No command-specific errors
1		Undefined
2	Error	Invalid selection
3-4		Undefined
5	Error	Too few data bytes received
6	Error	Device-specific command error
7-127		Undefined

Command 216 (0xD8): Write calibration configuration

This command is to write calibration configuration.

Table 146:
Request data bytes for write calibration configuration

Byte	Format	Description
0	Unsigned-8	Reynolds correction: 0: Disable, 1: Enable
1	Unsigned-8	Active MultiK Enable: 0: Disable, 1: Enable
2	Unsigned-8	KFactor type: 0: Velocity, 1: Reynolds
3 – 6	Float	Static KFactor
7	Unsigned-8	KFactor points
8 – 11	Float	Kinematic viscosity

Table 147:
Response data bytes for write calibration configuration

Byte	Format	Description
0	Unsigned-8	Reynolds correction
1	Unsigned-8	Active MultiK enable
2	Unsigned-8	KFactor type: 0: Velocity, 1: Reynolds
3 – 6	Float	Static KFactor
7	Unsigned-8	KFactor points
8 – 11	Float	Kinematic viscosity

Table 148:
Command-specific response codes for write calibration configuration

Code	Class	Description
0	Success	No command-specific errors
1-4		Undefined
5	Error	Too few data bytes received
6	Error	Device-specific command error
7	Error	In write protect mode
8-15		Undefined
16	Error	Access restricted
17-127		Undefined

Command 217 (0xD9): Write velocity KFactor table

This command is to write velocity KFactor table

Table 149:
Request data bytes for write velocity KFactor Table

Byte	Format	Description
0	Unsigned-8	Velocity KFactor index (1 - 6)
1	Unsigned-8	Velocity unit
2 - 5	Float	Velocity value
6 - 9	Float	Velocity KV value;

Table 150:
Response data bytes for write velocity KFactor Table

Byte	Format	Description
0	Unsigned-8	Velocity KFactor index (1 - 6)
1	Unsigned-8	Velocity unit
2 - 5	Float	Velocity value
6 - 9	Float	Velocity KV value;

Table 151:
Command-specific response codes for write velocity KFactor Table

Code	Class	Description
0	Success	No command-specific errors
1		Undefined
2	Error	Invalid selection
3-4		Undefined
5	Error	Too few data bytes received
6	Error	Device-specific command error
7	Error	In write protect mode
8-15		Undefined
16	Error	Access restricted
17-127		Undefined

Command 218 (0xDA): Write Reynolds KFactor Table

This command is to write Reynolds KFactor table.

Table 152:
Request data bytes for write Reynolds KFactor Table

Byte	Format	Description
0	Unsigned-8	Reynolds KFactor index (1 - 6)
1 - 4	Float	Reynolds value
5 - 8	Float	Reynolds KV value;

Table 153:
Response data bytes for write Reynolds KFactor Table

Byte	Format	Description
0	Unsigned-8	Reynolds KFactor index (1 - 6)
1 - 4	Float	Reynolds value
5 - 8	Float	Reynolds KV value;

Table 154:
Command-specific response codes for write Reynolds KFactor Table

Code	Class	Description
0	Success	No command-specific errors
1		Undefined
2	Error	Invalid selection
3-4		Undefined
5	Error	Too few data bytes received
6	Error	Device-specific command error
7	Error	In write protect mode
8-15		Undefined
16	Error	Access restricted
17-127		Undefined

Command 224 (0xE0): Read error limits

This command is to read flow meter error limits..

Table 155:
Request data bytes for read error limits

Byte	Format	Description
0	Unsigned-8	Error limit: 1. Correlation peak limit 2. Acceleration limit 3. Velocity low limit 4. Velocity high limit 5. Amp disc min 6. Amp disc max 7. Signal low limit 8. Sound speed limit 9. Errors allowed

Table 156:
Response data bytes for read error limits

Byte	Format	Description
0	Unsigned-8	Error limit: 1. Correlation peak limit 2. Acceleration limit 3. Velocity low limit 4. Velocity high limit 5. Amp disc min 6. Amp disc max 7. Signal low limit 8. Sound speed limit 9. Errors allowed
1-4	Float	Error limit value;

Table 157:
Command-specific response codes for read error limits

Code	Class	Description
0	Success	No command-specific errors
1		Undefined
2	Error	Invalid selection
3-4		Undefined
5	Error	Too few data bytes received
6	Error	Device-specific command error
7-127		Undefined

Command 225 (0xE1): Read signal setup

This command is to read flow meter signal setup.

Table 158:
Request data bytes for read signal setup

Byte	Format	Description
0	Unsigned-8	Signal setup type: 1. Delta T offset 2. Percentage peak 3. Min peak percentage 4. Max peak percentage

Table 159:
Response data bytes for read signal setup

Byte	Format	Description
0	Unsigned-8	Signal setup type: 1. Delta T offset 2. Percentage peak 3. Min peak percentage 4. Max peak percentage
1 - 4	Float	Signal setup value

Table 160:
Command-specific response codes for read signal setup

Code	Class	Description
0	Success	No command-specific errors
1		Undefined
2	Error	Invalid selection
3-4		Undefined
5	Error	Too few data bytes received
6	Error	Device-specific command error
7-127		Undefined

Command 226 (0xE2): Read flowmeter S/N

This command is to read flow meter s/n.

Table 161:
Request data bytes for read flowmeter S/N

Byte	Format	Description
0	Unsigned-8	Flowmeter S/N: 1. Electronic S/N 2. UP sensor 3. S/N 4. DN sensor S/N

Table 162:
Response data bytes for read flowmeter S/N

Byte	Format	Description
0	Unsigned-8	Signal setup type: 1. Electronic S/N 2. UP sensor 3. S/N 4. DN sensor S/N
1 - 16	Unsigned-8	S/N

Table 163:
Command-specific response codes for read flowmeter S/N

Code	Class	Description
0	Success	No command-specific errors
1		Undefined
2	Error	Invalid selection
3-4		Undefined
5	Error	Too few data bytes received
6	Error	Device-specific command error
7-127		Undefined

Command 227 (0xE3): Read flowmeter version

This command is to read flow meter version.

Table 164:
Request data bytes for read flow meter version

Byte	Format	Description
0	Unsigned-8	Flowmeter version 1. Main hardware version 2. Main software version

Table 165:
Response data bytes for read flow meter version

Byte	Format	Description
0	Unsigned-8	Version type: 1. Main hardware version 2. Main software version
1 - 8	Unsigned-8	Version number

Table 166:
Command-specific response codes for read flow meter version

Code	Class	Description
0	Success	No command-specific errors
1		Undefined
2	Error	Invalid selection
3-4		Undefined
5	Error	Too few data bytes received
6	Error	Device-specific command error
7-127		Undefined

Command 232 (0xE8): Write error limits

This command is to write flow meter error limits.

Table 167:
Request data bytes for write error limits

Byte	Format	Description
0	Unsigned-8	Error limit: Correlation peak limit Acceleration limit Velocity low limit Velocity high limit Amp disc min Amp disc max Signal low limit Sound speed limit Errors allowed
1 - 4	Float	Error limit value;

Table 168:
Response data bytes for write error limits

Byte	Format	Description
0	Unsigned-8	Error limit: Correlation peak limit Acceleration limit Velocity low limit Velocity high limit Amp disc min Amp disc max Signal low limit Sound speed limit Errors allowed
1 - 4	Float	Error limit value;

Table 169:
Command-specific response codes for write error limits

Code	Class	Description
0	Success	No command-specific errors
1		Undefined
2	Error	Invalid selection
3-4		Undefined
5	Error	Too few data bytes received
6	Error	Device-specific command error
7	Error	In write protect mode
8-15		Undefined
16	Error	Access restricted
17-127		Undefined

Command 233 (0xE9): Write signal setup

This command is to write flow meter signal setup..

Table 170:
Request data bytes for write signal setup

Byte	Format	Description
0	Unsigned-8	Signal setup type: Delta T offset percentage peak Min peak percentage Max peak percentage
1 - 4	Float	Signal setup value

Table 171:
Response data bytes for write signal setup

Byte	Format	Description
0	Unsigned-8	Signal setup type: Delta T offset percentage peak Min peak percentage Max peak percentage
1 - 4	Float	Signal setup value

Table 172:
Command-specific response codes for write signal setup

Code	Class	Description
0	Success	No command-specific errors
1		Undefined
2	Error	Invalid selection
3-4		Undefined
5	Error	Too few data bytes received
6	Error	Device-specific command error
7	Error	In write protect mode
8-15		Undefined
16	Error	Access restricted
17-127		Undefined

Command 239 (0xEF): Reset flow meter data

This command is to reset flow meter data.

Table 173:
Request data bytes for reset flow meter data

Byte	Format	Description
0	Unsigned-8	Reset type: 1. Reset error log 2. Forward inventory 3. Reverse inventory 4. Net inventory 5. Inventory time 6. All 7. Inventory

Table 174:
Response data bytes for reset flow meter data

Byte	Format	Description
0	Unsigned-8	Reset type: Reset error log Forward inventory Reverse inventory Net inventory Inventory time all Inventory

Table 175:
Command-specific response codes for reset flow meter data

Code	Class	Description
0	Success	No command-specific errors
1		Undefined
2	Error	Invalid selection
3-4		Undefined
5	Error	Too few data bytes received
6	Error	Device-specific command error
7	Error	In write protect mode
8-15		Undefined
16	Error	Access restricted
17-127		Undefined

Command 241 (0xF1): Read the factory setting

This command is to read the factory setting.

Table 176:
Request data bytes for read the factory setting

Byte	Format	Description
None		

Table 177:
Response data bytes for read the factory setting

Byte	Format	Description
0	Unsigned-8	Response time
		0.5s
		1s
		5s
		10s
		30s
1 - 4	Unsigned-32	60s
		Sample Size:
		2
		4
		8
		16
		32

Table 178:
Command-specific response codes for read the factory setting

Code	Class	Description
0	Success	No command-specific errors
1		Undefined
2	Error	Invalid selection
3-4		Undefined
5	Error	Too few data bytes received
6	Error	Device-specific command error
7-127		Undefined

Command 248 (0xF8): Write the factory setting

This command is to write the factory setting.

Table 179:
Request data bytes for write the factory setting

Byte	Format	Description
0	Unsigned-8	Response time
		0.5s
		1s
		5s
		10s
		30s
1 - 4	Unsigned-32	Sample size:
		2
		4
		8
		16
		32

Table 180:
Response data bytes for write the factory setting

Byte	Format	Description
0	Unsigned-8	Response time
		0.5s
		1s
		5s
		10s
		30s
1 - 4	Unsigned-32	Sample size:
		2
		4
		8
		16
		32

Table 181:
Command-specific response codes for write the factory setting

Code	Class	Description
0	Success	No command-specific errors
1		Undefined
2	Error	Invalid selection
3-4		Undefined
5	Error	Too few data bytes received
6	Error	Device-specific command error
7	Error	In write protect mode
8-15		Undefined
16	Error	Access restricted
17-127		Undefined

Command 253 (0xFD): Reset to factory setting

This command is to reset the setting to the factory default.

Table 182:
Request data bytes for reset to factory setting

Byte	Format	Description
None		

Table 183:
Response data bytes for reset to factory setting

Byte	Format	Description
None		

Table 184:
Command-specific response codes for reset to factory setting

Code	Class	Description
0	Success	No command-specific errors
1-4		Undefined
5	Error	Too few data bytes received
6	Error	Device-specific command error
7	Error	In write protect mode
8-15		Undefined
16	Error	Access restricted
17-127		Undefined

6.3 Additional device status

Command 48 returns 4 bytes of data, with the following status information:

Table 185: HART additional device status				
HART additional device status			Class	Device status bits set
Byte	Bit	Error description		
0	0	Amplitude error	Error	4, 7
	1	Low signal	Error	4, 7
	2	Sound speed error	Error	4, 7
	3	Velocity range	Error	4, 7
	4	Signal quality	Error	4, 7
	5	Cycle skip	Error	4, 7
	6	Reserve		
	7	Reserve		
1	0	Reserve		
	1	Reserve		
	2	Reserve		
	3	Reserve		
	4	Reserve		
	5	Reserve		
	6	Reserve		
	7	Reserve		

Table 185: HART additional device status				
HART additional device status			Class	Device status bits set
Byte	Bit	Error description		
2	0	FPGA error;		4, 7
	1	Setting files CRC error;		4, 7
	2	Flash error		4, 7
	3	KEY/LED error		4, 7
	4	I/O error		4, 7
	5	Display error		4, 7
	6	RTC error		4, 7
	7	Reserve		
3	0	In configure mode;		4, 0
	1	Not calibrated;		4, 0
	2	Reserve		
	3	Reserve		
	4	Reserve		
	5	Reserve		
	6	Reserve		
	7	Reserve		

6.4 Device variables

Table 186: Device variables

Measurement	Device variable code	Device variable classification code	
		Code	Classification
Velocity	0	67	Velocity
Actual volumetric	1	66	Volumetric flow
Standardized volumetric	2	66	Volumetric flow
Fwd. batch totals	3	68	Volumetric
Rev batch totals	4	68	Volumetric
Net batch totals	5	68	Volumetric
Batch totalizer time	6	70	Time
Fwd. inventory totals	7	68	Volumetric
Rev inventory totals	8	68	Volumetric
Net inventory totals	9	68	Volumetric
Inventory totalizer time	10	70	Time
Mass flow	11	72	Mass flow
Sound speed	12	67	Velocity
Reynolds	13	0	Not classified
Kfactor	14	0	Not classified
Transit time up	15	70	Time
Transit time Dn	16	70	Time
DeltaT	17	70	Time
Up signal quality	18	0	Not classified
Dn signal quality	19	0	Not classified
Up amp disc	20	0	Not classified
Dn amp disc	21	0	Not classified
SNR up	22	0	Not classified

Table 186: Device variables

Measurement	Device variable code	Device variable classification code	
		Code	Classification
SNR Dn	23	0	Not classified
ActiveTW up	24	0	Not classified
ActiveTW Dn	25	0	Not classified
Gain up	26	0	Not classified
Gain Dn	27	0	Not classified
Error status	28	0	Not classified
Reported error	29	0	Not classified
Up peak	30	0	Not classified
Down peak	31	0	Not classified
Peak% up	32	81	Analytical
Peak% Down	33	81	Analytical

6.5 HART engineering units

The unit types allowed for the AT600 flow meter device variables are listed below

Table 187: HART engineering units			
Device variable		Unit	
Code	Classification	Code	Description
64	Temperature	32	Degrees Celsius
		33	Degrees Fahrenheit
66	Volumetric flow	27	Cubic feet per day
		130	Cubic feet per hour
		15	Cubic feet per minute
		26	Cubic feet per second
		187	Standard cubic feet per day
		185	Standard cubic feet per hour
		123	Standard cubic feet per minute
		186	Standard cubic feet per second
		29	Cubic meter per day
		19	Cubic meter per hour
		131	Cubic meters per minute
		28	Cubic meters per second
		240	Million cubic meters per day
		187	Standard cubic meter per day
		188	Standard cubic meter per hour
189	Standard cubic meter per minute		
190	Standard cubic meter per second		
		235	Gallon per day
		136	Gallons per hour
		16	Gallons per minute
		22	Gallons per second
		135	Barrels per day
		134	Barrels per hour

Table 187: HART engineering units			
Device variable		Unit	
Code	Classification	Code	Description
		133	Barrels per minute
		132	Barrels per second
		174	Liters per day
		138	Liters per hour
		17	Liters per minute
		24	Liters per second
		25	Million liters per day
		177	Standard liter per day
		178	Standard liter per hour
		179	Standard liter per minute
		180	Standard liter per second
67	Velocity	20	Feet per second
		21	Meters per second
68	Volume	43	Cubic meter
		41	Cubic decimeter (liter)
		243	Mega liters
		244	Million cubic meter
		112	Cubic feet
		40	Gallon
		46	Barrel
		245	Mega gallons
		246	Million cubic feet
		172	Standard cubic meter
		171	Standard liters
		61	Kilogram
		62	Metric ton
		168	Standard cubic feet
		63	Pound
		247	Kilo pound
		64	Short tons

Table 187: HART engineering units

Device variable		Unit	
Code	Classification	Code	Description
69	Length	44	Feet
		47	Inch
		45	Meter
		49	Millimeter
70	Time	172	Nanoseconds
		171	Microseconds
		170	Milliseconds
		51	Seconds
		50	Minute
		52	Hour
		53	Day
72	Mass flow	73	Kilograms per seconds
		74	Kilograms per minute
		75	Kilograms per hour
		76	Kilograms per day
		242	Metric tons per second
		77	Metric tons per minute
		78	Metric tons per hour
		79	Metric tons per day
		80	Pounds per seconds
		81	Pounds per minute
		82	Pounds per hour
		83	Pounds per day
		241	Short ton per seconds
84	Short ton per minute		
85	Short ton per hour		
86	Short ton per day		

Table 187: HART engineering units

Device variable		Unit	
Code	Classification	Code	Description
73	Mass per volume	94	Pounds per cubic feet
		92	Kilograms per cubic meter
74	Viscosity	54	Centistokes
		248	Square meter per sec
81	Analytical	57	Percent
96	Acceleration	171	Feet per second squared
		172	Meter per second squared
0	Not Classification	38	dB
		156	Hertz

Appendix A. Specifications

A.1 Overall operation and performance

Fluid types

Liquids: acoustically conductive fluids, including most clean liquids, and many liquids with small amounts of entrained solids or gas bubbles

Flow measurement

Correlation Transit-Time™ mode

Pipe sizes

0.5 in. (15 mm) or greater

Pipe materials

All metals and most plastics. Consult Panametrics for concrete, composite materials, and highly corroded or lined pipes.

Accuracy

±1% of reading in application, for ≥2 in. (50 mm) pipe and >1 ft/s (0.3 m/s) velocity

±2% of reading in application, for <2 in. (50 mm) pipe and >1 ft/s (0.3 m/s) velocity

±0.5% in field calibration

Calibration

All meters are water calibrated and delivered with a traceable calibration certificate.

Repeatability

±0.2% of reading

Range (bidirectional)

-40 to +40 ft/s (-12 to +12 m/s)

Rangeability (overall)

400:1

Measurement parameters

Velocity, volumetric, and totalized flow

NOTE:

Installation assumes a fully developed, symmetrical flow profile (typically 10 diameters upstream and 5 diameters downstream of straight pipe run). Final installation accuracy is a function of multiple factors including fluid, temperature range, pipe centricity and others.

A.2 Electronics

Enclosure

Epoxy-coated, copper free, aluminum weatherproof type 4X/IP67

Dimensions

6.6 x 5.0 x 2.4 in. (168 x 128 x 61 mm)

Weight

3.5 lb/1.5 kg

Channels

One channel

Display

Graphic LCD (128 x 64 pixels)

Keypad

Six-button keypad for full functionality operation

Error display indicator

Green or red light

Power supplies

Standard: 85 to 265 VAC, 50/60 Hz

Optional: 12 to 28 VDC, $\pm 5\%$

Power consumption

In-rush: 10 W

Normal operation: 5 W

Operating temperature

-4 to 131°F (-20 to 55°C)

Storage temperature

-40 to 158°F (-40 to 70°C)

Outputs (based on configuration)

- 4-20 mA (24VDC powered, 600 Ω maximum load, 1500 VDC isolation)
- Frequency, pulse, alarm (passive output, 100 VDC, 1 A/1 W maximum, 1500 VDC isolation)
- HART (FSK modulation, category flow, protocol version 7.5, device revision 2, MFG ID 157, device type code 127, number of device variables 34)
- Modbus/RS485 (half-duplex, 1500 VDC isolation)

NOTE:

Analog outputs are Namur NE43 compliant.

Certification

CE (LVD,EMC), US/CAN Ordinary Locations

A.3 Clamp-on ultrasonic flow transducers

Materials

- AT6 transducer
 - Transducer body: aluminum (ASTM AL6061)
 - Fixture body: aluminum (ASTM AL6061)/stainless steel (ASTM A316)
- C-RS transducer
 - Transducer body: stainless steel (ASTM A316)
 - Fixture body: stainless steel
- UTXDR transducer
 - Transducer body: aluminum (ASTM AL6061)
 - Fixture body: aluminum (ASTM AL6061)/stainless steel (ASTM A304)
- CF-LP transducer
 - Transducer body: stainless steel (ASTM A316)
 - Fixture body: aluminum (ASTM AL6061)
- C-PT transducer
 - Transducer body: stainless steel (ASTM A316)
 - Fixture body: stainless steel

NOTE:

Contact Panametrics for other transducer models.

Temperature range

- **AT6 transducer:** -40 to 302°F (-40 to 150°C)
- **C-RS transducer:** -40 to 302°F (-40 to 150°C)
- **UTX transducer:** -40 to 248°F (-40 to 120°C)
- **CF-LP transducer:** -40 to 446°F (-40 to 230°C)
- **C-PT transducer:** -4 to 410°F (-20 to 210°C)

NOTE:

Contact Panametrics for other transducer models

Humidity range

Up to 90% RH

NOTE:

Contact Panametrics for tropicalization of the unit for 100% RH.

Altitude range

Up to 2000 m (6500 ft) maximum

CAT transducer cables

Cable: RG316 coaxial cable, up to 90 m (300 ft) long,
Temperature range: -40 to 302°F (-40 to 150°C)

Couplant

Standard: solid couplant

Optional: liquid couplant

Rating

Standard: General purpose (IP66 or IP68)

NOTE:

See specific transducer model for exact rating.

A.4 General

A.4.1 Wiring cable specifications and requirements

- Cable diameter range for PWR connection: 7 to 12mm, refer to gland Hole 1 on figure 24
- Cable diameter range for Hart, Modbus and I/O connection: 5 to 8mm, refer to gland Hole 2,3 and 4 in figure 24
- Temperature range of cable for PWR, Hart, Modbus and IO connection: 14° to 185°F (-10° to 85°C)

The cable should meet the CE and UL standard below:

- Conductor cross section solid range:
0.2 mm² to 2.5 mm²
- Conductor cross section stranded range:
0.2 mm² to 2.5 mm²
- Conductor cross section stranded, with ferrule without plastic sleeve range: 0.25 mm² to 1 mm²
- Conductor cross section stranded, with ferrule with plastic sleeve range: 0.25 mm² to 1 mm
- Conductor cross section AWG/kcmil range:
12 to 26 AWG according to UL/CUL range: 14 to 28

A.4.2 Cable fixing requirement and gland torque

Refer to figure 24 for the gland hole position.

To make a reliable IP67 sealing performance of the enclosure during cabling, the gland must be tightened well, below torque value is a reference to make a reliable NEMA 4X/IP67 sealing between cable and gland:

- Operation torque for gland hole 1 and 5: 2.7 N.M
- Operation torque for gland hole 2, 3 and 4: 2.5 N.M

A.4.3 Display languages

English/Chinese/German/French/Italian/Japanese/Portuguese/Russian/Spanish/Swedish/Turkish

NOTE:

The meter will be set to the language specified by the customer before shipping.

A.4.4 Product models

Based on the line power type, the AT600 ultrasonic flow meter is available in two series:

- Models of AC meter: 85-264VAC, 50-60Hz, 10W, up to AT6-**-*****-***-*_1-**-***-**-*, AT6KIT-*1, AT6KIT-*2, AT6KIT-*3 and AT6KIT-*7
- Models of DC meter: 12-28VDC, 10W, up to AT6-**-*****-***-*_2-**-***-**-*, AT6KIT-*4, AT6KIT-*5, AT6KIT-*6 and AT6KIT-*8

NOTE:

* in the product model name is either a number from 0-9 or a letter from A-Z.

B.3 Initial settings

The values for the initial measurement settings immediately after commissioning of the meter and verification of proper operation should be entered below.

Table 189: Initial settings

Parameter	Initial value
Pipe OD	
Pipe ID	
Pipe wall thickness	
Pipe material	
Pipe sound speed	
Lining thickness	
Lining material	
Transducer ID	
Transducer frequency	
Transducer wedge type	
Transducer wedge angle	
Transducer wedge SOS	
Transducer TW	
Traverses	
Fluid type	
Fluid SOS	
Fluid minimum SOS	
Fluid maximum SOS	
Fluid temperature	
Transducer spacing	

B.4 Diagnostic parameters

The values for the diagnostic parameters immediately after commissioning of the meter and verification of proper operation should be entered below. These initial values can then be compared to current values to help diagnose any future malfunction of the system.

Table 190: Diagnostic parameters

Parameter	Initial value
Velocity	
Actual volumetric	
Standardized volumetric	
Fwd. batch totals	
Rev batch totals	
Net batch totals	
Batch totalizer time	
Fwd. inventory totals	
Rev inventory totals	
Net inventory totals	
Inventory totalizer time	
Mass flow	
Sound Speed	
Reynolds	
Kfactor	
Transit time up	
Transit time Dn	
DeltaT	
Up signal quality	
Dn signal quality	
Up Amp Disc	
Dn Amp Disc	

Table 190: Diagnostic parameters

Parameter	Initial value
SNR up	
SNR Dn	
ActiveTW up	
ActiveTW Dn	
Gain up	
Gain Dn	
Error status	
Reported error	
Up peak	
Down peak	
Peak % Up	
Peak % Down	

Appendix C. Updating the firmware in the field

C.1 Introduction

The AT600 firmware can be updated in the field. However, before attempting a firmware update, read the information in this section thoroughly to ensure a successful update process.

NOTE:

The instructions in this appendix are also available in Panametrics document p/n 714-1418.

C.1.1 System requirements

Make sure that your AT600 flow meter system meets the following requirements:

- Verify that your current AT600 firmware version is **01.02.25** or later.
- Verify that you have the AquaTrans flow meter software update version **20161117V1.2** or later available to run on your PC.
- Verify that your AT600 service port has a 2-wire RS485 connection to your PC, and that the connection baud rate is set to **115200 baud**.
- Verify that your AT600 firmware binary file is **version 1.02.25** or later.

C.1.2 Preparation

To ensure a successful firmware update, be prepared for the following:

- Allow about **10 minutes** for the firmware update to complete.
- Before starting the firmware update, make sure that the AT600 is in **normal measurement mode**.
- The AT600 **main power** must remain **ON** throughout the firmware update. **DO NOT** turn the main power **OFF** until the firmware update has been completed.
- Because the firmware update uses the AT600 **Modbus/service port**, you must **NOT** allow any other AT600 Modbus activity during the firmware update.
- During the firmware update, the AT600 will attempt to **validate** the new firmware image file. At the end of the update process, if the validation was successful, the AT600 will reboot with the updated firmware installed. However, if the validation was not successful, the original firmware will still be installed after the reboot.

C.2 Performing the firmware update

If your AT600 flow meter system meets all of the requirements discussed on the previous page and you are prepared to perform the firmware update according to those guidelines, proceed with the instructions in this section.

C.2.1 Check the current firmware version

To determine the firmware version currently installed in your AT600, access the following information screen:

Main menu > program > advanced > flow meter data > main board > SW version

For reference, an example of this screen is shown in figure 36 below.

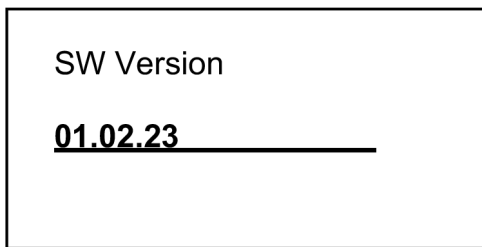


Figure 36: Example software version screen

NOTE:

As indicated on the previous page, the current version of your AT600 firmware must be **01.02.23** or later.

If your version is older than this, you cannot use this update method. Software versions **01.02.24**, **01.03.xx**, **02.xx.xx** are examples of acceptable versions.

C.2.2 Update steps

If your AT600 firmware version qualifies for the field firmware update process, complete the following steps:

1. Prepare the RS485 Modbus connection:
 - a. Disconnect the main power from the AT600.
 - b. Wire the Modbus connection as described in "Wiring the Modbus Communication."
2. Locate the AquaTrans flow meter Software update (version **20161117V1.2** or later) software on your PC. If the folder containing the software is zipped, you must unzip it prior to use.
3. Run the update software by clicking on the **upgrade.exe** file (see figure 37 below). Installation of the software on the PC is not required.



Figure 37: Running the update.exe software

4. Click on the COM port button and enter the specific com port on the PC that is connected to the AT600 Modbus/service port.
5. Click on the open image file button, and open the Panametrics image file to be used for the AT600 firmware update.
6. Click on the start To upgrade button. After verifying that the selected image file and Com port are correct, click the OK button to start the update process.
7. After the progress bar indicates that the firmware update is 100% complete (about 10 minutes), the message shown in figure 38 below will be displayed. Note that the AT600 will automatically reboot in 30 seconds.

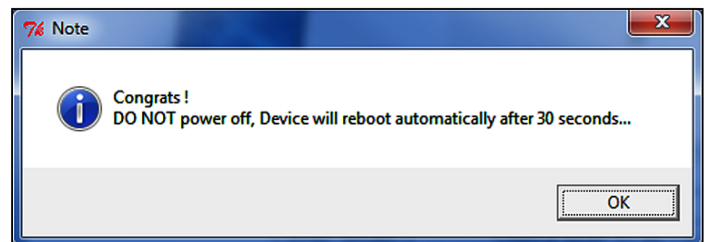


Figure 38: Reboot message

8. After the reboot is complete, refer to "Check the current firmware version" and confirm that the new firmware version has been installed. If the original firmware version is still installed, the AT600 was not able to validate the image file that was used - contact Panametrics for assistance.

C.3 Clearing an S2 warning

After the firmware update, the AT600 may show an S2 warning. If so, complete the following steps:

1. In the update software, click on the com port button and select the specific port that was used for the update (see top red box in figure 39 below).
2. Click on the clear S2 warning button (see bottom red box in figure 39 below).

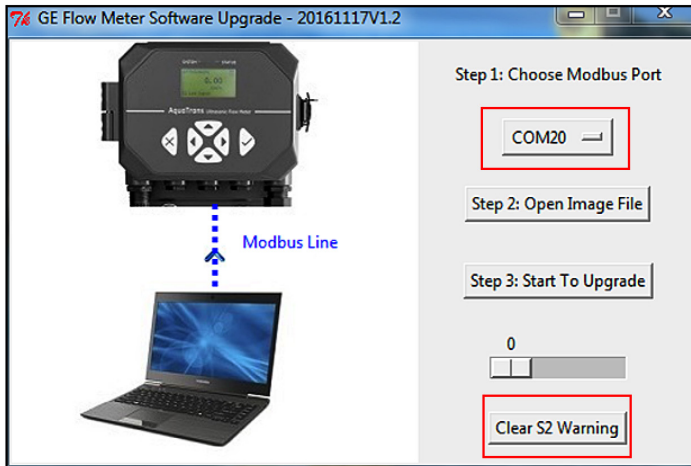


Figure 39: Clearing an S2 warning

3. After about 15 seconds, a screen similar to figure 40 below is displayed. Click OK and then reboot the AT600 to confirm that the S2 error has been cleared.

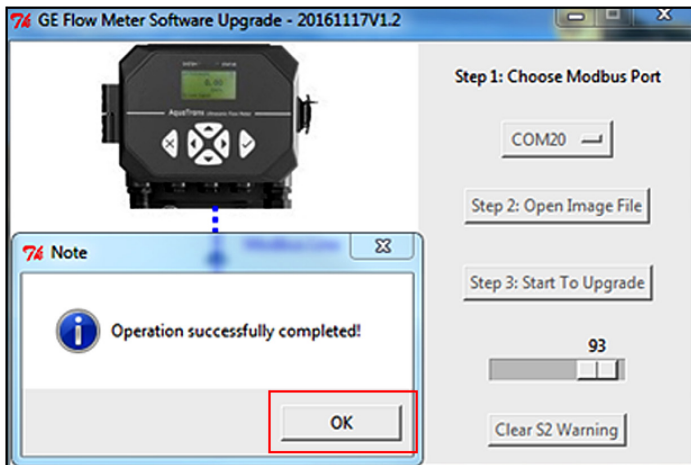


Figure 40: S2 warning successfully cleared

C.4 Support

If the firmware update was unsuccessful, reboot the AT600 and repeat the procedure described in this appendix. If there is still a problem, send an email to mstechsupport@bakerhughes.com and describe the problem in detail.

Appendix D. Menu maps

D.1 The display measurement menu

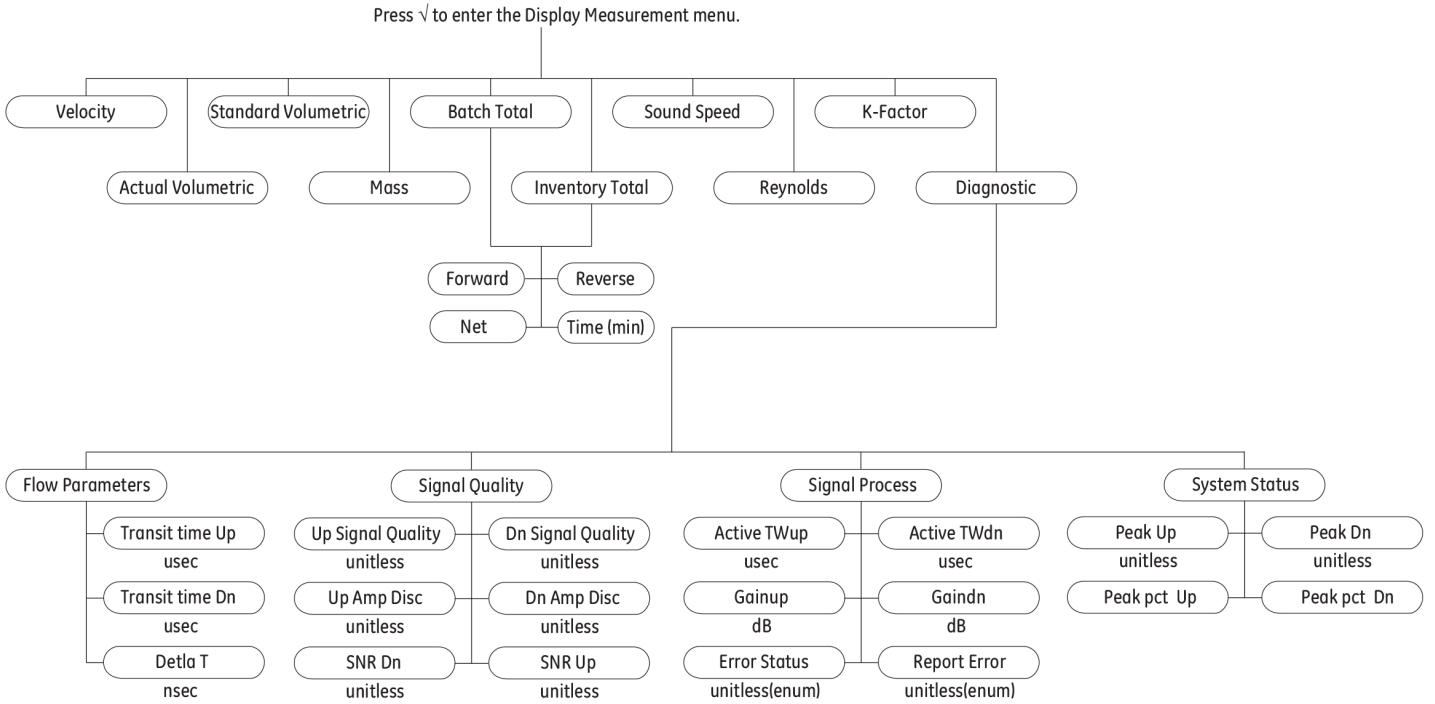


Figure 41: The display measurement menu

D.2 The main menu

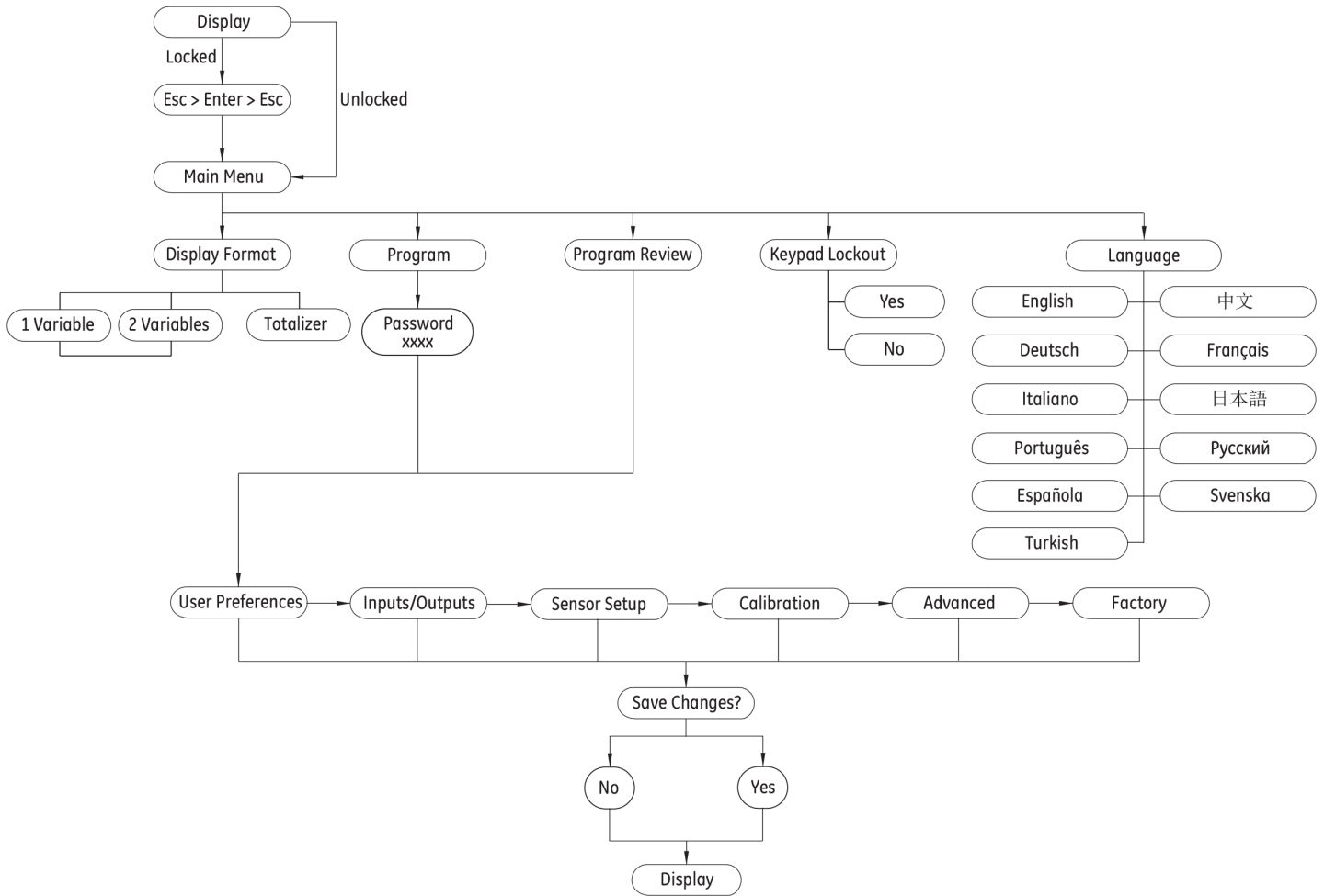


Figure 42: The main menu

D.3 The main menu > user preferences menu

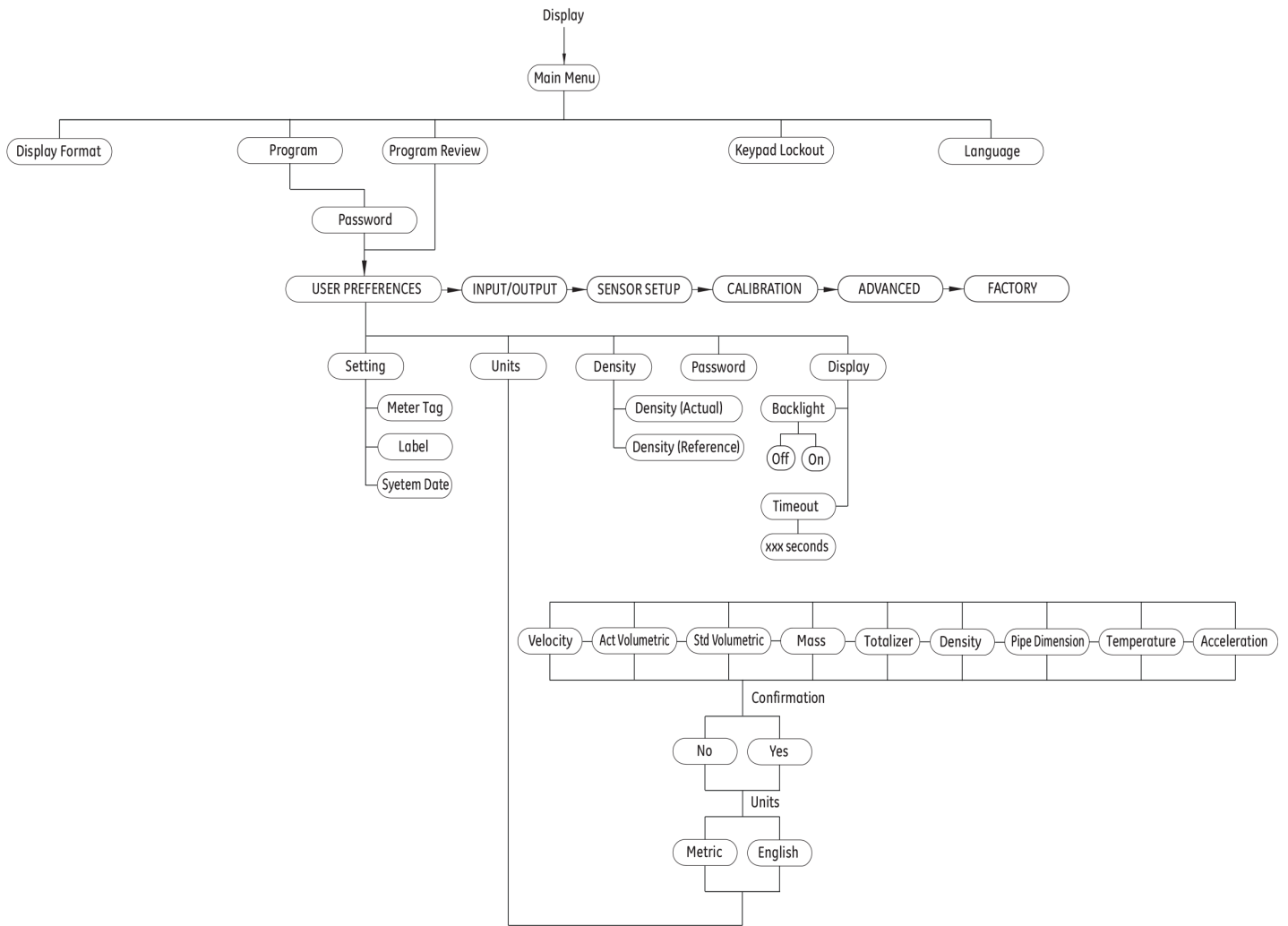


Figure 43: The main menu > user preferences menu

D.4 The main menu > inputs/outputs menu

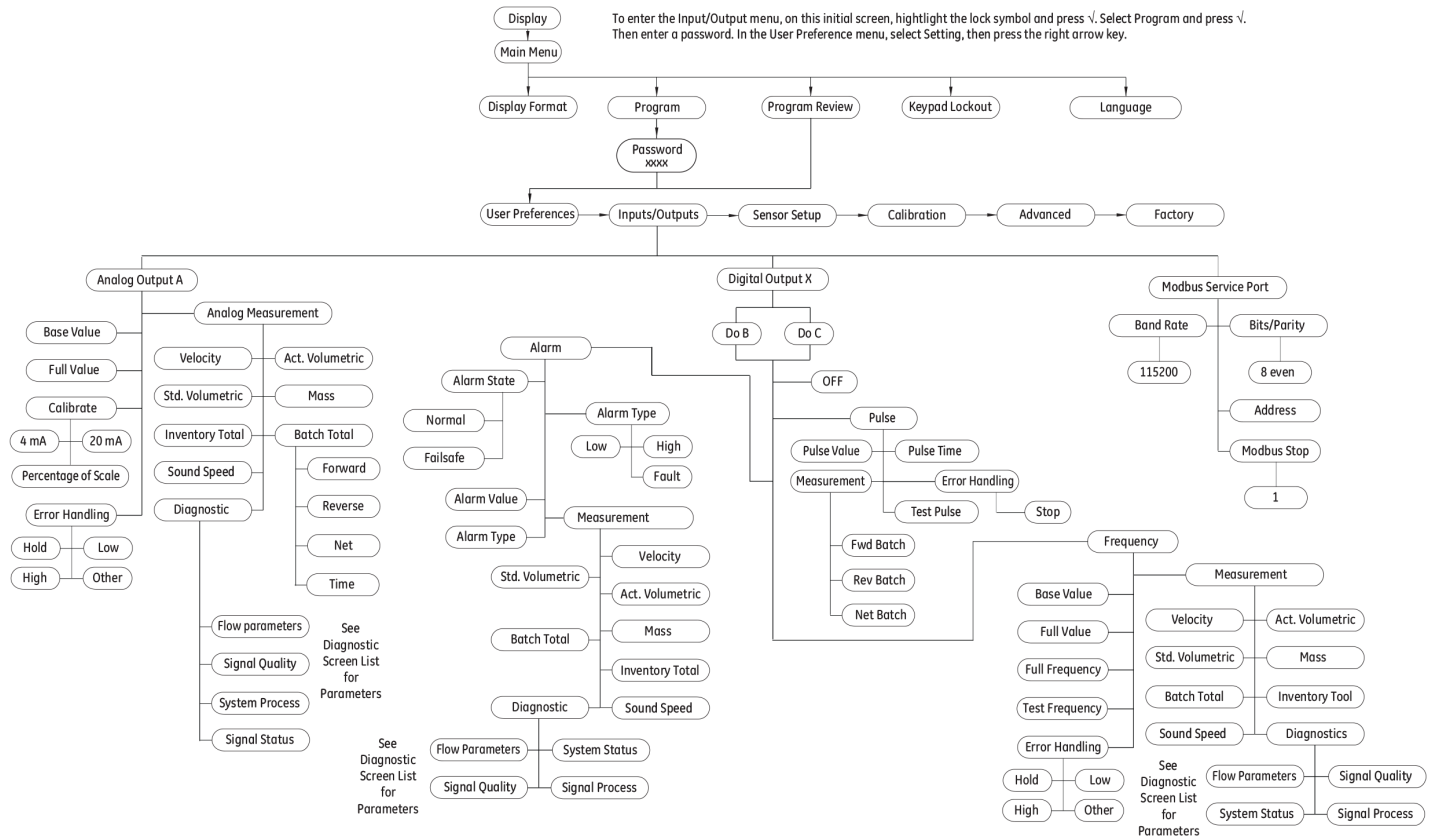


Figure 44: The main menu > inputs/outputs menu

D.5 The main menu > sensor setup menu

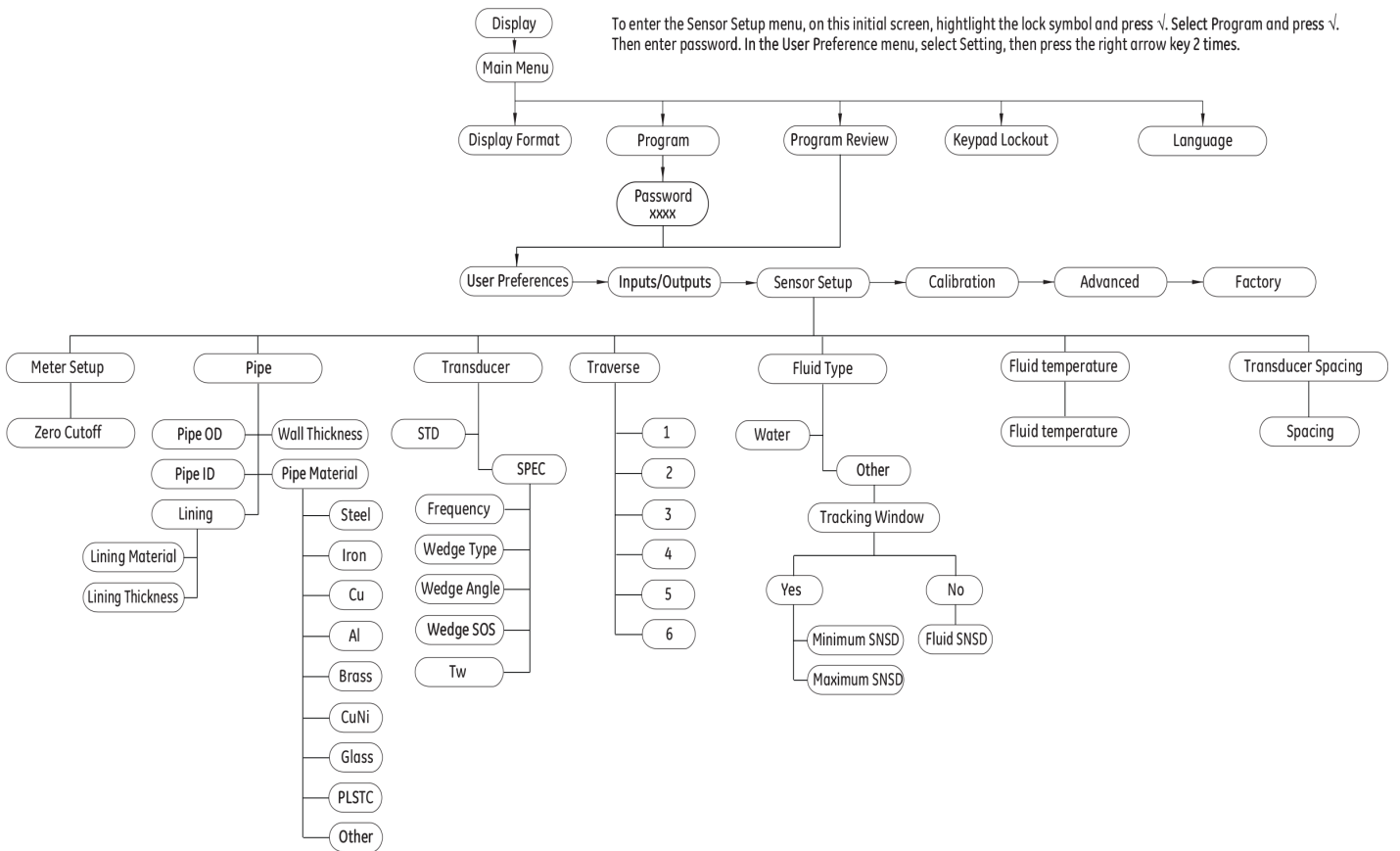


Figure 45: The main menu > sensor setup menu

D.6 The main menu > calibration menu

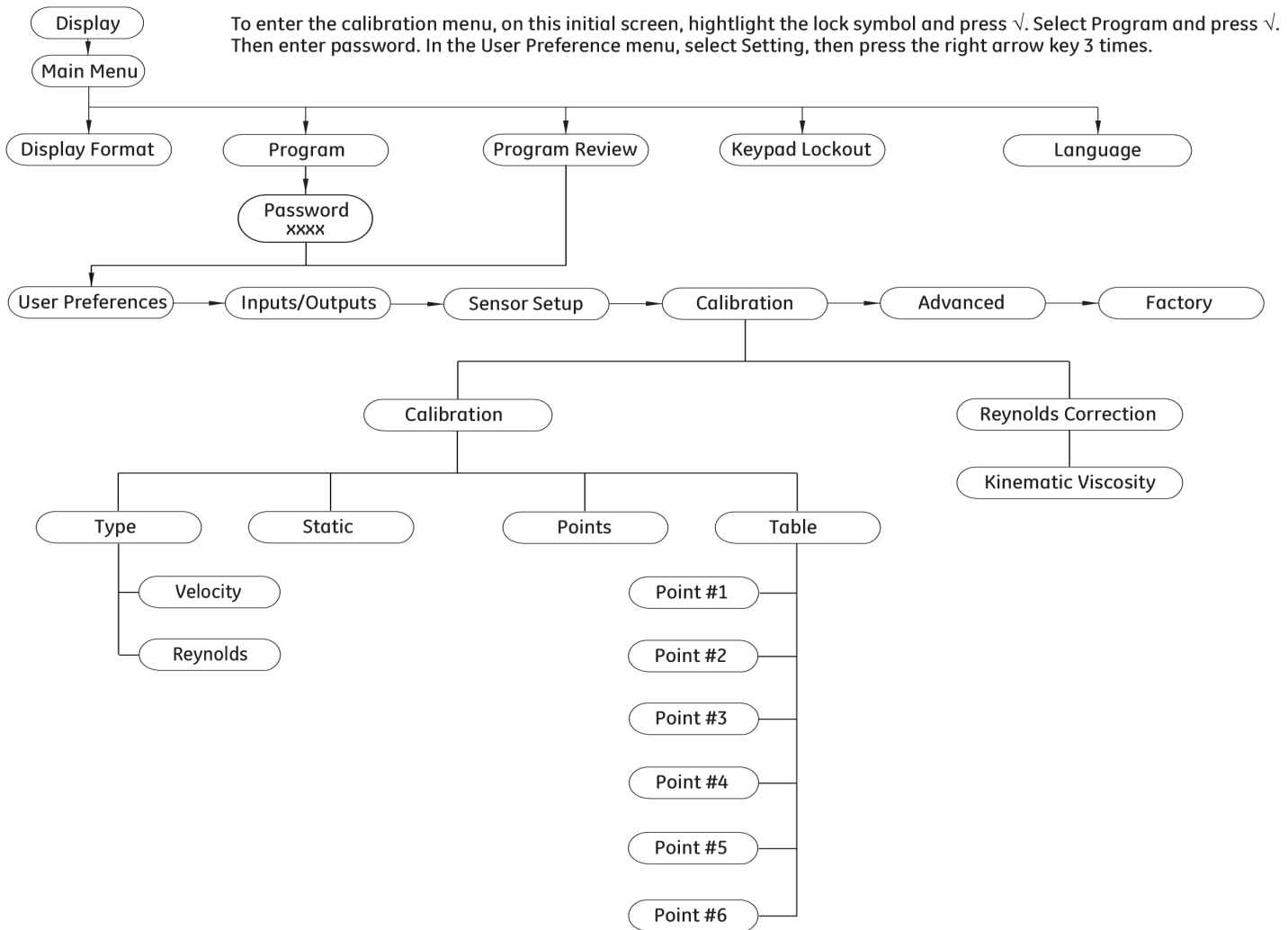


Figure 46: The main menu > calibration menu

D.7 The main menu > advanced menu

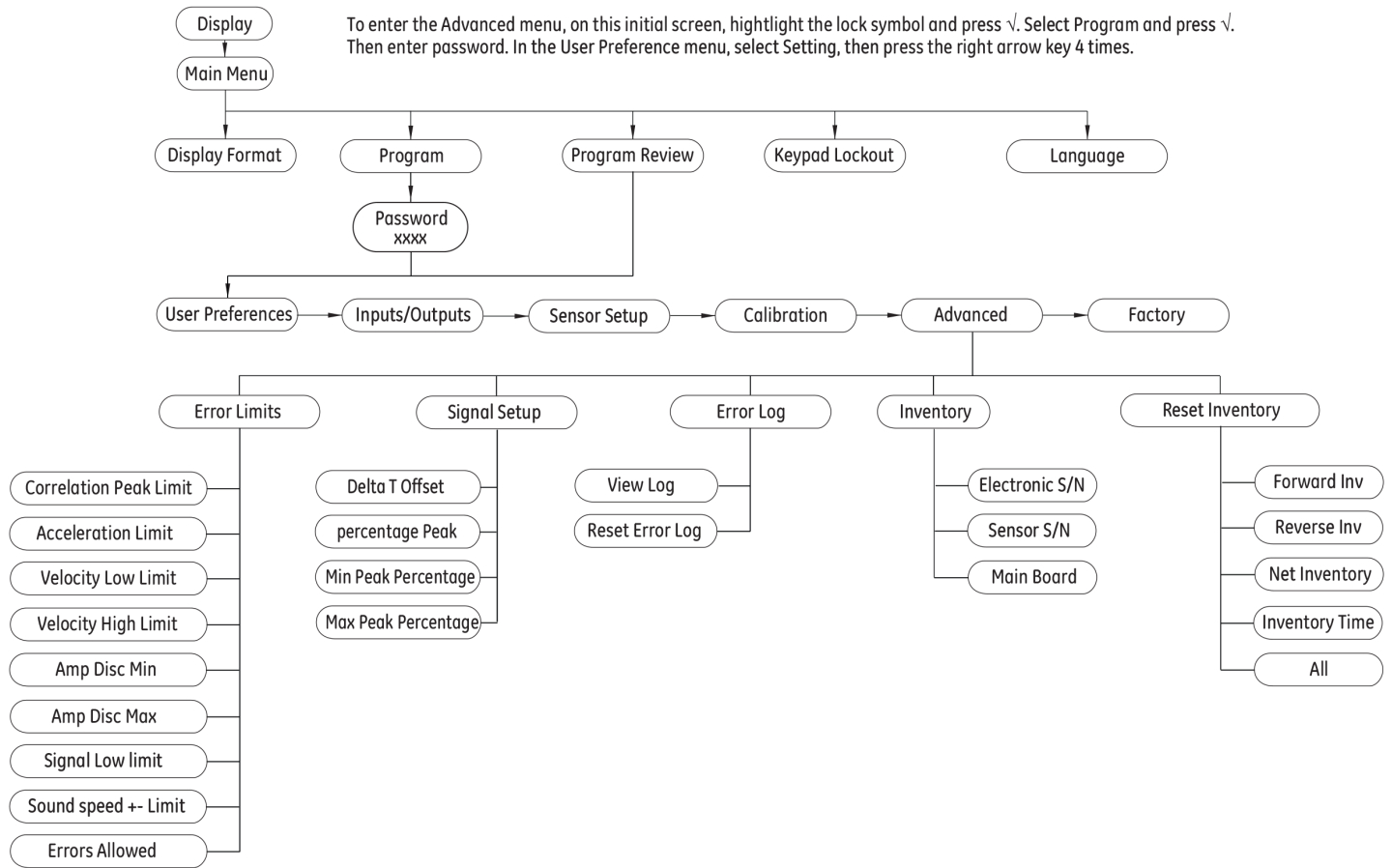


Figure 47: The main menu > advanced menu

D.8 The main menu > factory menu

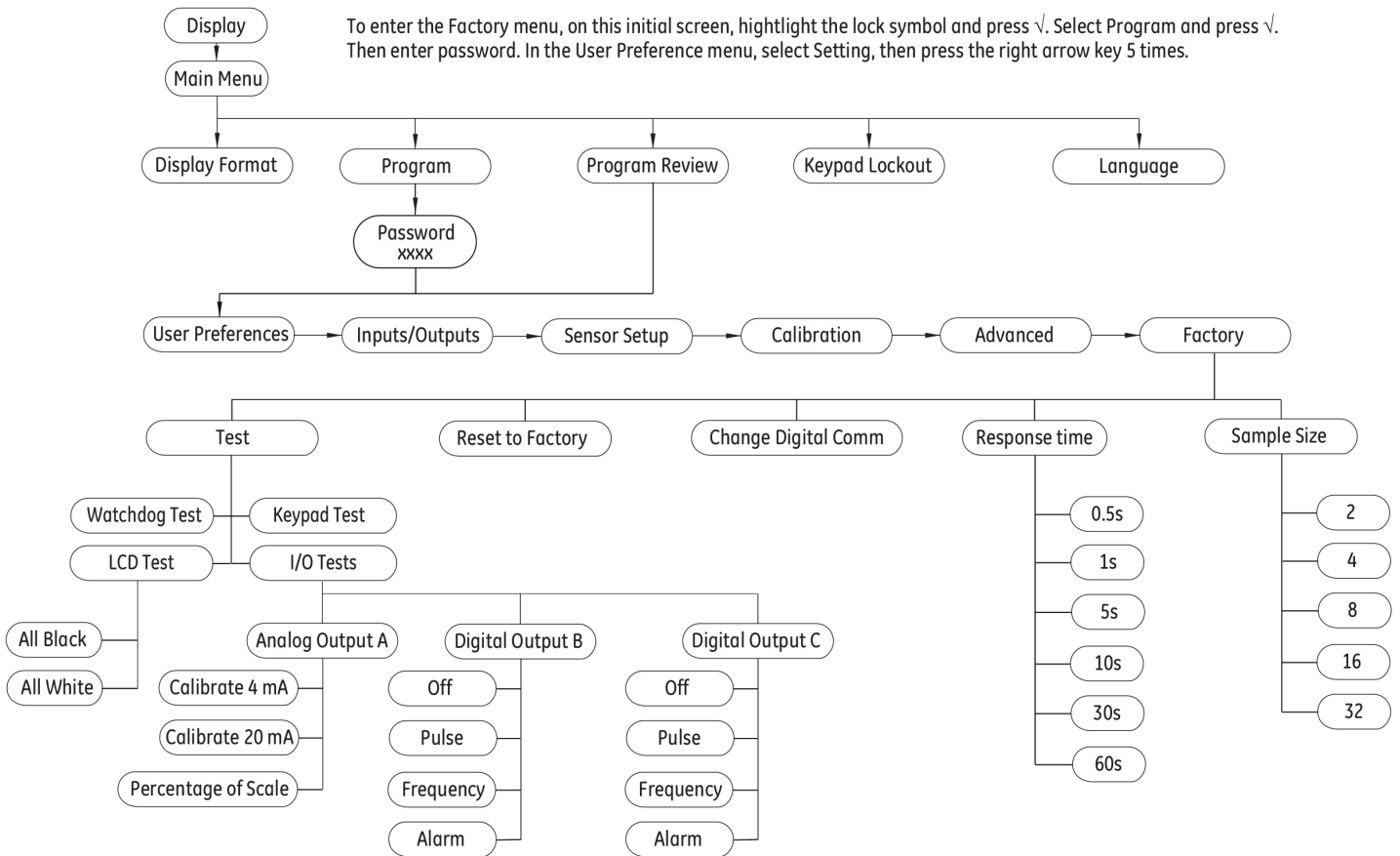


Figure 48: The main menu > factory menu

A		F	
Alarm measurement type, setting.....	59	Fixture location	7
Alarm state, setting.....	59	Flow error string.....	89
Alarm type, setting	60	Flowcell problems	93
Alarm value, setting	60	Fluid problems.....	93
Alarm, setting.....	58	Fluid temperature, programming.....	85
Analog measurements, setting.....	49	Fluid type, programming	84
Analog output menu, programming.....	48	Frequency error handling, setting	57
Analog output, calibrating.....	50	Frequency measurement type, setting.....	56
Arrow keys	32		
AT transducers system.....	1	H	
AT600	1	HART	64, 105
Keypad operation.....	32	Device Identification.....	105
Unpacking	4	Device specific commands.....	106
AT600 Mounting installation base	6	HART Additional device status	166
		HART commands	105
B		Enter/exit fixed loop current.....	119
Backlight.....	46	Login with password	107
Base value/full value/frequency, setting.....	56	Logout and Save.....	109
		Logout without Saving	109
C		Read alarm configuration	128
Clamp-on fixture		Read Analog measurement range values.....	117
Mounting onto pipe.....	8	Read Backlight setting.....	113
		Read calibration configuration	149
D		Read current user Access Right.....	110
Decimal places		Read Density value	112
Programming for totalizer	35	Read digital configuration.....	125
Density.....	45	Read error limits	155
Device Identification.....	105	Read factory setting	163
Device specific commands.....	106	Read flowmeter S/N.....	157
Device variables.....	167	Read flowmeter version.....	158
Diagnostics	93	Read Fluid information.....	141
Digital communications, programming.....	61	Read Frequency configuration.....	127
Digital output menu, programming	51	Read loop current error handling.....	118
Digital output, Disabling	52	Read pipe lining attribute.....	136
Display.....	46	Read pipe material	136
Display Format.....	39	Read pipe size	135
Display, programming the	33	Read pulse configuration.....	126
Document number	i	Read Reynolds KFactor table	151
Down arrow key.....	32	Read sensor meter setup	137
		Read signal setup.....	156
E		Read transducer information.....	138
EI Low signal	90	Read transducer traverses and spacing	140
Electronics enclosure, installing	5	Read velocity KFactor table.....	150
Enter/exit fixed loop current.....	119	Reset flow meter data	162
Enter key	32	Reset to factory setting	165
Error display	89	Sends new password	110
Error handling, setting	50	Set Analog measurement range values	123
Error header	89	Set loop current error handling	124
Escape key.....	32		

Set loop current gain	121	MODBUS stop bits	64
Set loop current percentage	122	Modbus/service port	61
Set loop current zero	120	O	
Test digital output	134	One or two-variable screens, Changing	33
Write alarm configuration	133	One- or two-variable screens, measurement type	34
Write calibration configuration	152	P	
Write Density value	116	Password	46
Write digital configuration	129	Pipe lining, setting	72
Write display backlight	117	Pipe material, setting	71, 72
Write error limits	159	Pipe OD/ID/wall thickness	70
Write factory setting	164	Pipe problems	94
Write fluid information	148	Pipe, programming	70
Write pipe lining attribute	143	Program menu	41
Write pipe material	142	Program review menu	42
Write pipe Size	141	Publication date	i
Write pulse configuration	130, 131	Pulse error handling, setting	55
Write Reynolds KFactor table	154	Pulse output, setting	52
Write sensor meter setup	144	Pulse setting, example	54
Write transducer information	145	Pulse time, setting	53
Write transducer traverses and spacing	147	Pulse value, setting	53
Write unit Group	114	R	
Write velocity KFactor table	153	Read alarm configuration	128
HART engineering units	168	Read Analog measurement range values	117
I		Read Backlight setting	113
Inputs/outputs	48	Read calibration configuration	149
K		Read current user Access Right	110
Keypad	32	Read Density value	112
Keypad lockout	40	Read digital configuration	125
L		Read error limits	155
Language, programming	41	Read flowmeter S/N	157
Left arrow key	32	Read flowmeter version	158
Login with password	107	Read fluid information	141
Logout and save	109	Read Frequency configuration	127
Logout without saving	109	Read loop current error handling	118
M		Read pipe lining attribute	136
Main menu		Read pipe material	136
Entering	39	Read pipe size	135
Measurement type for digital output, setting	52	Read pulse configuration	126
Menu map	31	Read Reynolds KFactor table	151
Meter setup	67	Read sensor meter setup	137
Meter tag	43	Read signal setup	156
MODBUS	62, 97	Read the factory setting	163
Baud rate, Selecting	62	Read transducer information	138
Modbus		Read transducer traverses and spacing	140
Address, Selecting	63	Read velocity KFactor table	150
Modbus bits/parity, Selecting	63	Registration	vii
MODBUS map	97	Reset flow meter data	162

Reset to factory setting	165
Revision number	i
Right arrow key	32
RoHS compliance	ix
S	
Safety	
Auxiliary equipment	viii
General issues.....	vii
Personal equipment	viii
Safety codes.....	3
Sends new password	110
Sensor setup.....	66
Services.....	vii
Set Analog measurement range values	123
Set loop current error handling	124
Set loop current gain	121
Set loop current percentage.....	122
Set loop current zero.....	120
Settings	43
Special transducer, setting	77
Starting or stopping	37
T	
Terms and conditions.....	vii
Test alarms	61
Test digital output	134
Test frequency	58
Theory of operation.....	2
Timeout.....	47
Totalizer	
Resetting.....	38
Totalizer measurement	37
Totalizer programming	
Decimal places	35
Pulse settings.....	54
Totalizer screens, changing measurement or value.....	35
Transducer location	7
Transducer spacing, programming	86
Transducer, programming	74
Transit-time flow measurement	2
Traverses, programming	83
Typographical conventions.....	vii

U	
Units setting	44
Universal commands.....	105
Up arrow key	32
User preferences	
Density.....	45
Display.....	46
Password	46
Settings	43
Units setting	44
W	
Warranty.....	vii
WEEE compliance.....	ix
Write	116
Write alarm configuration	133
Write calibration configuration	152
Write Density value	116
Write digital configuration.....	129
Write display backlight	117
Write error limits	159
Write fluid information	148
Write frequency configuration	
HART commands	
Write frequency configuration.....	131, 132
Write pipe lining attribute.....	143
Write pipe material	142
Write pipe Size	141
Write pulse configuration	130, 131
Write Reynolds KFactor table	154
Write sensor meter setup	144
Write the factory setting	164
Write transducer information.....	145
Write transducer traverses and spacing	147
Write unit group.....	114
Write velocity KFactor table.....	153
Z	
Zero cutoff, setting	67

Customer support centers

Americas

The Boston Center

The Boston Center
1100 Technology Park Drive
Billerica, MA 01821
U.S.A.
Tel: 800 833 9438 (toll-free)
978 437 1000
E-mail: @bakerhughes.com

Europe

Ireland

Sensing House
Shannon Free Zone East Shannon,
County Clare Ireland
Tel: +353 61 61470200
E-mail: @bakerhughes.com

Panametrics, a Baker Hughes Business, provides solutions in the toughest applications and environments for moisture, oxygen, liquid and gas flow measurement. Experts in flare management, Panametrics technology also reduces flare emissions and optimizes performance.

With a reach that extends across the globe, Panametrics' critical measurement solutions and flare emissions management are enabling customers to drive efficiency and achieve carbon reduction targets across critical industries including: Oil & Gas; Energy; Healthcare; Water and Wastewater; Chemical Processing; Food & Beverage and many others.

Join the conversation and follow us on LinkedIn
[linkedin.com/company/panametricscompany](https://www.linkedin.com/company/panametricscompany)